

ETSI EN 300 219 V2.1.1 (2016-08)



HARMONISED EUROPEAN STANDARD

**Land Mobile Service;
Radio equipment transmitting signals to initiate
a specific response in the receiver;
Harmonised Standard covering the essential requirements
of article 3.2 of the Directive 2014/53/EU**

Reference

REN/ERM-TGDMMR-349

Keywords

analogue, mobile, PMR, radio, signalling

ETSI

650 Route des Lucioles
F-06921 Sophia Antipolis Cedex - FRANCE

Tel.: +33 4 92 94 42 00 Fax: +33 4 93 65 47 16

Siret N° 348 623 562 00017 - NAF 742 C
Association à but non lucratif enregistrée à la
Sous-Préfecture de Grasse (06) N° 7803/88

Important notice

The present document can be downloaded from:
<http://www.etsi.org/standards-search>

The present document may be made available in electronic versions and/or in print. The content of any electronic and/or print versions of the present document shall not be modified without the prior written authorization of ETSI. In case of any existing or perceived difference in contents between such versions and/or in print, the only prevailing document is the print of the Portable Document Format (PDF) version kept on a specific network drive within ETSI Secretariat.

Users of the present document should be aware that the document may be subject to revision or change of status. Information on the current status of this and other ETSI documents is available at
<https://portal.etsi.org/TB/ETSIDeliverableStatus.aspx>

If you find errors in the present document, please send your comment to one of the following services:
<https://portal.etsi.org/People/CommitteeSupportStaff.aspx>

Copyright Notification

No part may be reproduced or utilized in any form or by any means, electronic or mechanical, including photocopying and microfilm except as authorized by written permission of ETSI.

The content of the PDF version shall not be modified without the written authorization of ETSI.
The copyright and the foregoing restriction extend to reproduction in all media.

© European Telecommunications Standards Institute 2016.
All rights reserved.

DECT™, **PLUGTESTS™**, **UMTS™** and the ETSI logo are Trade Marks of ETSI registered for the benefit of its Members.
3GPP™ and **LTE™** are Trade Marks of ETSI registered for the benefit of its Members and of the 3GPP Organizational Partners.
GSM® and the GSM logo are Trade Marks registered and owned by the GSM Association.

Contents

Intellectual Property Rights	7
Foreword.....	7
Modal verbs terminology.....	7
1 Scope	8
2 References	8
2.1 Normative references	8
2.2 Informative references.....	9
3 Definitions, symbols and abbreviations	10
3.1 Definitions.....	10
3.2 Symbols.....	10
3.3 Abbreviations	10
4 Speech equipment with signalling.....	11
4.1 Applicability.....	11
4.1.1 General.....	11
4.1.2 Equipment with speech and signalling functions.....	11
4.1.3 Equipment with an add-on signalling unit	11
5 General and operational requirements.....	12
5.1 General	12
5.1.1 Environmental profile	12
5.1.2 Choice of model for testing	12
5.2 Mechanical and electrical design.....	12
5.2.1 General.....	12
5.2.2 Controls	12
5.2.3 Transmitter shut-off facility (time-out).....	12
6 Test conditions, power sources and ambient temperatures	12
6.1 Normal and extreme test conditions	12
6.2 Test power source.....	12
6.3 Normal test conditions.....	13
6.3.1 Normal temperature and humidity	13
6.3.2 Normal test power source	13
6.3.2.1 Mains voltage.....	13
6.3.2.2 Regulated lead-acid battery power sources used on vehicles.....	13
6.3.2.3 Other power sources.....	13
6.4 Extreme test conditions	13
6.4.1 Extreme temperatures	13
6.4.2 Extreme test source voltages.....	14
6.4.2.1 Mains voltage.....	14
6.4.2.2 Regulated lead-acid battery power sources used on vehicles.....	14
6.4.2.3 Power sources using other types of batteries.....	14
6.4.2.4 Other power sources.....	14
6.5 Procedure for tests at extreme temperatures.....	14
6.5.0 Thermal balance.....	14
6.5.1 Procedure for equipment designed for continuous transmission.....	15
6.5.2 Procedure for equipment designed for intermittent transmission	15
7 General conditions of measurement	15
7.1 Arrangements for test signals at the input of the receiver	15
7.2 Receiver mute or squelch facility	15
7.3 Normal test signals, (wanted and unwanted signals).....	15
7.4 Encoder for receiver measurements	16
7.5 Test Load (artificial antenna)	16
7.6 Test sites and general arrangements for radiated measurements	16
7.7 Transmitter automatic shut-off facility (time-out).....	16

7.8	Modes of operation of the transmitter	16
7.9	Facilities for access between the receiver demodulator output and its decoder	16
7.10	Calling indicator	17
7.11	Reset	17
7.12	Reset time	17
7.13	Test of equipment with a duplex filter	17
8	Technical characteristic of the transmitter	17
8.1	Frequency error	17
8.1.0	Applicability	17
8.1.1	Definition	17
8.1.2	Method of measurement	17
8.1.3	Limits	18
8.2	Carrier power (conducted)	18
8.2.0	Applicability	18
8.2.1	Definitions	18
8.2.2	Method of measurement	19
8.2.3	Limits	19
8.3	Effective radiated power (field strength)	19
8.3.0	Applicability	19
8.3.1	Definition	19
8.3.2	Method of measurement	19
8.3.3	Limits	21
8.4	Adjacent and alternate channel power	22
8.4.0	Applicability	22
8.4.1	Definition	22
8.4.2	Method of measurement	22
8.4.3	Limits	24
8.5	Transmitter spurious emissions	24
8.5.0	Applicability	24
8.5.1	Definition	24
8.5.2	Method of measuring the power level	24
8.5.3	Method of measuring the effective radiated power	25
8.5.4	Transmitter spurious emissions	26
8.6	Intermodulation attenuation	27
8.6.0	Applicability	27
8.6.1	Definition	27
8.6.2	Method of measurement	28
8.6.3	Limits	29
8.7	Transmitter Attack Time	29
8.7.0	Applicability	29
8.7.1	Definition	29
8.7.2	Method of measurement	29
8.7.3	Limits	30
8.8	Transmitter release time	30
8.8.0	Applicability	30
8.8.1	Definition	30
8.8.2	Method of measurement	30
8.8.3	Limits	31
8.9	Transient frequency behaviour of the transmitter	31
8.9.0	Applicability	31
8.9.1	Definitions	31
8.9.2	Method of measurement	31
8.9.3	Limits	35
9	Technical characteristics of the receiver	35
9.1	Reference sensitivity (responses)	35
9.1.1	Definition	35
9.1.2	Reference sensitivity (response)	35
9.2	Maximum usable sensitivity (responses, conducted)	35
9.2.0	Applicability	35
9.2.1	Definition	35

9.2.2	Method of measurement ("up-down method")	36
9.2.3	Limits	36
9.3	Average usable sensitivity (field strength, responses)	36
9.3.0	Applicability	36
9.3.1	Definition	37
9.3.2	Method of measurement under normal test conditions	37
9.3.3	Method of measurement of the average usable sensitivities under extreme test conditions	38
9.3.4	References for degradation measurements	39
9.3.4.1	Definition	39
9.3.4.2	Procedures for measurements using the test fixture	39
9.3.4.3	Procedures for measurements using the test site	40
9.3.5	Limits	40
9.4	Co-channel rejection	41
9.4.0	Applicability	41
9.4.1	Definition	41
9.4.2	Method of measurement	41
9.4.3	Limits	42
9.5	Adjacent channel selectivity	42
9.5.0	Applicability	42
9.5.1	Definition	42
9.5.2	Method of measurement	43
9.5.3	Limits	44
9.6	Spurious response rejection	44
9.6.0	Applicability	44
9.6.1	Definition	44
9.6.2	Introduction to the method of measurement	44
9.6.3	Method of search over the "limited frequency range"	45
9.6.4	Method of measurement	46
9.6.5	Limits	47
9.7	Intermodulation response	47
9.7.0	Applicability	47
9.7.1	Definition	47
9.7.2	Method of measurement	47
9.7.3	Limits	48
9.8	Blocking or desensitization	48
9.8.0	Applicability	48
9.8.1	Definition	48
9.8.2	Method of measurement	49
9.8.3	Limits	50
9.9	Receiver spurious radiations	50
9.9.0	Applicability	50
9.9.1	Definition	50
9.9.2	Method of measuring the power level	50
9.9.3	Method of measuring the effective radiated power	51
9.9.4	Limits	52
10	Duplex operation	52
10.0	Applicability	52
10.1	Receiver desensitization (with simultaneous transmission and reception)	52
10.1.1	Definition	52
10.1.2	Method of measurement when the equipment operates with a duplex filter	53
10.1.3	Method of measurement when the equipment operates with separate Tx and Rx antennas	54
10.1.4	Limits	54
10.2	Receiver spurious response rejection (with simultaneous transmission and reception)	55
10.2.1	Definition	55
10.2.2	Method of measurement	55
10.2.3	Limits	56
11	Testing for compliance with technical requirements	56
11.1	Test conditions, power supply and ambient temperatures	56
11.2	Interpretation of the measurement results	56

Annex A (normative): Radiated measurement	58
--	-----------

A.1	Test sites and general arrangements for measurements involving the use of radiated fields	58
A.1.0	General	58
A.1.1	Anechoic chamber	58
A.1.2	Anechoic chamber with a conductive ground plane	59
A.1.3	Open Area Test Site (OATS)	60
A.1.4	Test antenna	61
A.1.5	Substitution antenna	61
A.1.6	Measuring antenna	62
A.2	Guidance on the use of radiation test sites	62
A.2.0	General	62
A.2.1	Verification of the test site	62
A.2.2	Preparation of the EUT	62
A.2.3	Power supplies to the EUT	62
A.2.4	Volume control setting for analogue speech tests	62
A.2.5	Range length	63
A.2.6	Site preparation	63
A.3	Coupling of signals	64
A.3.1	General	64
A.3.2	Data signals	64
A.3.3	Speech and analogue signals	64
A.3.3.0	General	64
A.3.3.1	Acoustic coupler description	64
A.3.3.2	Calibration	65
A.4	Test fixture	65
A.4.1	Description	65
A.4.2	Calibration	65
A.4.3	Mode of use	66
Annex B (normative): Specification for some particular measurement arrangements		67
B.1	Power measuring receiver specification	67
B.1.0	General	67
B.1.1	IF filter	67
B.1.2	Attenuation indicator	69
B.1.3	RMS value indicator	69
B.1.4	Oscillator and amplifier	69
B.2	Spectrum analyser specification	69
B.2.1	Adjacent and alternate channel power measurement	69
B.2.2	Unwanted emissions measurement	70
B.3	Integrating and power summing device	70
Annex C (normative): Relationship between the present document and the essential requirements of Directive 2014/53/EU		71
History		73

Intellectual Property Rights

IPRs essential or potentially essential to the present document may have been declared to ETSI. The information pertaining to these essential IPRs, if any, is publicly available for **ETSI members and non-members**, and can be found in ETSI SR 000 314: "*Intellectual Property Rights (IPRs); Essential, or potentially Essential, IPRs notified to ETSI in respect of ETSI standards*", which is available from the ETSI Secretariat. Latest updates are available on the ETSI Web server (<https://ipr.etsi.org/>).

Pursuant to the ETSI IPR Policy, no investigation, including IPR searches, has been carried out by ETSI. No guarantee can be given as to the existence of other IPRs not referenced in ETSI SR 000 314 (or the updates on the ETSI Web server) which are, or may be, or may become, essential to the present document.

Foreword

This Harmonised European Standard (EN) has been produced by ETSI Technical Committee Electromagnetic compatibility and Radio spectrum Matters (ERM).

The present document has been prepared under the Commission's standardisation request C(2015) 5376 final [i.7] to provide one voluntary means of conforming to the essential requirements of Directive 2014/53/EU on the harmonisation of the laws of the Member States relating to the making available on the market of radio equipment and repealing Directive 1999/5/EC [i.5].

Once the present document is cited in the Official Journal of the European Union under that Directive, compliance with the normative clauses of the present document given in table C.1 confers, within the limits of the scope of the present document, a presumption of conformity with the corresponding essential requirements of that Directive, and associated EFTA regulations.

National transposition dates	
Date of adoption of this EN:	21 March 2016
Date of latest announcement of this EN (doa):	30 June 2016
Date of latest publication of new National Standard or endorsement of this EN (dop/e):	31 December 2016
Date of withdrawal of any conflicting National Standard (dow):	31 December 2017

Modal verbs terminology

In the present document "**shall**", "**shall not**", "**should**", "**should not**", "**may**", "**need not**", "**will**", "**will not**", "**can**" and "**cannot**" are to be interpreted as described in clause 3.2 of the [ETSI Drafting Rules](#) (Verbal forms for the expression of provisions).

"**must**" and "**must not**" are **NOT** allowed in ETSI deliverables except when used in direct citation.

1 Scope

The present document applies to constant envelope angle modulation systems for use in the land mobile service, using the available bandwidth, operating on radio frequencies between 30 MHz and 1 GHz, with channel separations of 12,5 kHz, 20 kHz and 25 kHz intended for transmission and/or reception of signals used to initiate a specific response in the receiver.

Table 1: Radiocommunications service frequency bands

Radiocommunications service frequency bands	
Transmit	30 MHz to 1 000 MHz
Receive	30 MHz to 1 000 MHz

The present document applies to non-speech and to the non-speech part of combined speech/non-speech analogue equipment. In the present document, non-speech radio equipment is defined as a radio equipment transmitting a signal to initiate a specific response in the receiver. The equipment shall comprise a transmitter and associated encoder and/or a receiver and associated decoder. The encoder and/or decoder may be a separate piece of equipment, in which case compliance to the present document covers the encoder and/or decoder in connection with the transmitter and/or receiver equipment.

In the present document different requirements are given for the different radio frequency bands, channel separations, environmental conditions and types of equipment, where appropriate.

The types of equipment covered by the present document are as follows:

- Base Station: equipment fitted with an antenna socket;
- Mobile Station: equipment fitted with an antenna socket;
- Handportable stations:
 - a) fitted with an antenna socket; or
 - b) without an external antenna socket (integral antenna equipment) but fitted with a permanent internal or a temporary internal 50 Ω Radio Frequency (RF) connector which allows access to the transmitter output and the receiver input.

Handportable equipment without an external or internal RF connector and without the possibility of having a temporary internal 50 Ω RF connector is not covered by the present document. Integral antenna equipment is covered by ETSI EN 300 341 [i.1] (see the corresponding scope).

The present document contains requirements to demonstrate that "... *Radio equipment shall be so constructed that it both effectively uses and supports the efficient use of radio spectrum in order to avoid harmful interference*" and that "...*radio equipment supports certain features ensuring access to emergency services*" [i.5].

In addition to the present document, other ENs that specify technical requirements in respect of essential requirements under other parts of article 3 of the Radio Equipment Directive [i.5] may apply to equipment within the scope of the present document.

2 References

2.1 Normative references

References are either specific (identified by date of publication and/or edition number or version number) or non-specific. For specific references, only the cited version applies. For non-specific references, the latest version of the referenced document (including any amendments) applies.

Referenced documents which are not found to be publicly available in the expected location might be found at <http://docbox.etsi.org/Reference>.

NOTE: While any hyperlinks included in this clause were valid at the time of publication, ETSI cannot guarantee their long term validity.

The following referenced documents are necessary for the application of the present document.

- [1] Recommendation ITU-T O.41 (1994): "Psophometer for use on telephone-type circuits".
- [2] ETSI TR 100 028 (V1.4.1) (12-2001) (all parts): "Electromagnetic compatibility and Radio spectrum Matters (ERM); Uncertainties in the measurement of mobile radio equipment characteristics".
- [3] ETSI EN 300 086 (V2.1.2) (08-2016): "Land Mobile Service; Radio equipment with an internal or external RF connector intended primarily for analogue speech; Harmonised Standard covering the essential requirements of article 3.2 of the Directive 2014/53/EU".
- [4] IEC 60489-3 (1988): "Methods of measurement for radio equipment used in the mobile services. Part 3: Receivers for A3E or F3E emissions".
- [5] ETSI TR 100 028-2 (V1.4.1) (12-2001): "Electromagnetic compatibility and Radio spectrum Matters (ERM); Uncertainties in the measurement of mobile radio equipment characteristics; Part 2".

2.2 Informative references

References are either specific (identified by date of publication and/or edition number or version number) or non-specific. For specific references, only the cited version applies. For non-specific references, the latest version of the referenced document (including any amendments) applies.

NOTE: While any hyperlinks included in this clause were valid at the time of publication, ETSI cannot guarantee their long term validity.

The following referenced documents are not necessary for the application of the present document but they assist the user with regard to a particular subject area.

- [i.1] ETSI EN 300 341 (V1.4.1): "Land Mobile Service; Radio equipment using an integral antenna transmitting signals to initiate a specific response in the receiver; Harmonised Standard covering the essential requirements of article 3.2 of the Directive 2014/53/EU".
- [i.2] ETSI EN 300 793 (1998): "Electromagnetic compatibility and Radio spectrum Matters (ERM); Land mobile service; Presentation of equipment for type testing".
- [i.3] ETSI TR 102 273 (V1.2.1) (all parts): "Electromagnetic compatibility and Radio spectrum Matters (ERM); Improvement on Radiated Methods of Measurement (using test site) and evaluation of the corresponding measurement uncertainties".
- [i.4] ANSI C63.5 (2006): "American National Standard for Calibration of Antennas Used for Radiated Emission Measurements in Electromagnetic Interference (EMI) Control-Calibration of Antennas (9 kHz to 40 GHz)".
- [i.5] Directive 2014/53/EU of the European Parliament and of the Council of 16 April 2014 on the harmonisation of the laws of the Member States relating to the making available on the market of radio equipment and repealing Directive 1999/5/EC.
- [i.6] CEPT/ERC/REC 74-01E: "Unwanted emissions in the spurious domain" (Siófok 1998, Nice 1999, Sesimbra 2002; Hradec Kralove 2005).
- [i.7] Commission Implementing Decision C(2015) 5376 final of 4.8.2015 on a standardisation request to the European Committee for Electrotechnical Standardisation and to the European Telecommunications Standards Institute as regards radio equipment in support of Directive 2014/53/EU of the European Parliament and of the Council.

3 Definitions, symbols and abbreviations

3.1 Definitions

For the purposes of the present document, the following terms and definitions apply:

angle modulation: either phase modulation (G3) or frequency modulation (F3)

base station: equipment fitted with an antenna socket, for use with an external antenna, and intended for use in a fixed location

conducted measurements: measurements which are made using a direct 50 Ω connection to the equipment under test

handportable station: equipment either fitted with an antenna socket or an integral antenna, or both, normally used on a stand-alone basis, to be carried on a person or held in the hand

integral antenna: antenna designed to be connected to the equipment without the use of a 50 Ω external connector and considered to be part of the equipment

NOTE: An integral antenna may be fitted internally or externally to the equipment.

mobile station: mobile equipment fitted with an antenna socket, for use with an external antenna, normally used in a vehicle or as a transportable station

psophometric weighting network: psophometric weighting network is described in Recommendation ITU-T O.41 [1]

radiated measurements: measurements which involve the absolute measurement of a radiated field

3.2 Symbols

For the purposes of the present document, the following symbols apply:

t_a	transmitter attack time
P_c	transmitter steady state carrier power
F_c	transmitter steady state frequency
t_{am}	transmitter measured attack time
t_{al}	transmitter attack time limit
df_e	transmitter steady state frequency error
t_r	transmitter release time
t_{rm}	transmitter measured release time
t_{rl}	transmitter release time limit

3.3 Abbreviations

For the purposes of the present document, the following abbreviations apply:

AC	Alternating Current
bit	binary digit
dB	decibel
dB μ V	decibel relative to 1 μ V
dBm	decibel relative to 1 mW
emf	electro-motive force
IF	Intermediate Frequency
OATS	Open Area Test Site
RF	Radio Frequency
rms	root mean square
Rx	Receiver
SINAD	(Signal + Noise + Distortion)/(Noise + Distortion)

SR Switching Range
Tx Transmitter

4 Speech equipment with signalling

4.1 Applicability

4.1.1 General

Where several harmonised standards are applicable to the equipment then the following shall be followed to avoid double testing of the same parameters.

4.1.2 Equipment with speech and signalling functions

In the case of combined speech/non-speech equipment the speech part shall be tested to ETSI EN 300 086 [3] and additionally the tests described in the following clauses of the present document shall be carried out:

- clause 8.4: Adjacent channel power;
- clause 9.2: Maximum usable sensitivity (responses, conducted);
- clause 9.3: Average usable sensitivity (responses, field strength) in the case of equipment having an integral antenna.

These requirements also apply for equipment with an analogue output facility provided for test purposes only.

Additionally, the measurement of the spurious emissions (clause 8.5) shall be performed when an equipment, previously tested to ETSI EN 300 086 [3] is being tested to the present document with an add-on signalling unit. If the equipment has been originally combined for analogue and signalling operation, the measurement of the spurious emissions need not to be performed again if the signalling port(s) (and the signalling circuits/modules) were active while making this measurement for the test ETSI EN 300 086 [3].

4.1.3 Equipment with an add-on signalling unit

In the case where an equipment has already been tested according to the present document and is re-tested with an add-on-signalling unit using another type of modulation without affecting any other characteristic of the equipment, only some additional measurements shall be performed; they shall ensure that the equipment fulfils the requirements of the following clauses:

- clause 8.4: adjacent channel power;
- clause 8.5: spurious emissions;
- clause 9.2: maximum usable sensitivity (responses, conducted);
- clause 9.3: average usable sensitivity (responses, field strength).

In the case where signalling is transmitted simultaneously with analogue speech, the speech part of the equipment is tested according to ETSI EN 300 086 [3], and it shall also be checked that the signalling does not cause the adjacent channel power and spurious emissions to exceed the appropriate limits.

5 General and operational requirements

5.1 General

5.1.1 Environmental profile

The technical requirements of the present document apply under the environmental profile for operation of the equipment, which shall be declared by the manufacturer, but as a minimum, shall be that specified in the test conditions contained in the present document.

5.1.2 Choice of model for testing

All necessary setting up instructions and other product information shall be made available with the equipment to be tested, in accordance with article 10.8 of Directive 2014/53/EU [i.5].

NOTE: Guidance on the presentation of equipment is also given in ETSI EN 300 793 [i.2].

5.2 Mechanical and electrical design

5.2.1 General

Equipment shall be designed, constructed and manufactured in accordance with sound engineering practice, and with the aim of minimizing harmful interference to other equipment and services.

5.2.2 Controls

Those controls which if maladjusted might increase the interfering potentialities of the equipment shall not be accessible to the user.

5.2.3 Transmitter shut-off facility (time-out)

When a timer for an automatic shut-off facility is operative, at the moment of the time-out the transmitter shall automatically be switched off. (The activation of the transmitter key shall reset the timer). A shut off facility shall be inoperative for the duration of the measurements unless it has to remain operative to protect the equipment.

6 Test conditions, power sources and ambient temperatures

6.1 Normal and extreme test conditions

Measurements shall be made under normal test conditions and also, where stated, under extreme test conditions.

The test conditions and procedures shall be as specified in clauses 6.2 and 6.5.

6.2 Test power source

During measurements the power source of the equipment shall be replaced by a test power source capable of producing normal and extreme test voltages as specified in clauses 6.3.2 and 6.4.2. The internal impedance of the test power source shall be low enough for its effect on the test results to be negligible. For the purpose of tests, the voltage of the power source shall be measured at the input terminals of the equipment.

If the equipment is provided with a permanently connected power cable, the test voltage shall be that measured at the point of connection of the power cable to the equipment.

For battery operated equipment, the batteries shall be removed and the test power source shall be applied as close to the battery terminals as practicable.

During the tests the power source voltages shall be maintained within a tolerance of $< \pm 1$ % relative to the voltage at the beginning of each test. The value of this tolerance is critical to power measurements, using a smaller tolerance will provide better measurement uncertainty values.

6.3 Normal test conditions

6.3.1 Normal temperature and humidity

The normal temperature and humidity conditions for the tests shall be any convenient combination of temperature and humidity within the following ranges:

- temperature: +15 °C to +35 °C;
- relative humidity: 20 % to 75 %.

When it is impracticable to carry out the tests under these conditions, the ambient temperature and relative humidity during the tests shall be recorded.

6.3.2 Normal test power source

6.3.2.1 Mains voltage

The normal test voltage for equipment to be connected to the mains shall be the nominal mains voltage. For the purpose of the present document, the nominal voltage shall be the declared voltage or any of the declared voltages for which the equipment was designed.

The frequency of the test power source, corresponding to the AC mains, shall be between 49 Hz and 51 Hz.

6.3.2.2 Regulated lead-acid battery power sources used on vehicles

When the radio equipment is intended for operation from the usual types of regulated lead-acid battery power source used on vehicles, the normal test voltage shall be 1,1 x the nominal voltage of the battery (for nominal voltages of 6 V and 12 V, these are 6,6 V and 13,2 V respectively).

6.3.2.3 Other power sources

For operation from other power sources or types of battery (primary or secondary), the normal test voltage shall be that declared by the equipment manufacturer.

6.4 Extreme test conditions

6.4.1 Extreme temperatures

For tests at extreme temperatures, measurements shall be made in accordance with the procedures specified in clause 6.5, at the upper and lower temperatures of one of the following range:

- -20 °C to +55 °C:
 - all mobile and handportable equipment;
 - base stations for outdoor/uncontrolled climate conditions.

- 0 °C to 40 °C:
- base stations for indoor/controlled climatic conditions.

For the purpose of clause 8.1.3 an additional reduced extreme temperature range of 0 °C to +30 °C shall be used when appropriate.

In the case of base station equipment, the manufacturer shall declare in which conditions the equipment is intended to be installed.

The temperature range is used shall be recorded.

6.4.2 Extreme test source voltages

6.4.2.1 Mains voltage

The extreme test voltage for equipment to be connected to an AC mains source shall be the nominal mains voltage $\pm 10\%$.

6.4.2.2 Regulated lead-acid battery power sources used on vehicles

When the equipment is intended for operation from the usual types of regulated lead-acid battery power sources used on vehicles, the extreme test voltages shall be 1,3 and 0,9 x the nominal voltage of the battery (for a nominal voltage of 6 V, these are 7,8 V and 5,4V respectively and for a nominal voltage of 12 V, these are 15,6 V and 10,8 V respectively).

6.4.2.3 Power sources using other types of batteries

The lower extreme test voltages for equipment with power sources using the following batteries shall be:

- for the nickel metal-hydride, Leclanché or the lithium type: 0,85 times the nominal battery voltage;
- for the mercury or nickel-cadmium type: 0,9 times the nominal battery voltage.

No upper extreme test voltages apply.

In the case where no upper extreme test voltage above the nominal voltage is applicable the corresponding four extreme test conditions are:

- V_{\min}/T_{\min} , V_{\min}/T_{\max} ;
- $(V_{\max} = \text{nominal})/T_{\min}$, $(V_{\max} = \text{nominal})/T_{\max}$.

6.4.2.4 Other power sources

For equipment using other power sources, or capable of being operated from a variety of sources, the extreme test voltages shall be those declared by the equipment manufacturer.

6.5 Procedure for tests at extreme temperatures

6.5.0 Thermal balance

Before measurements are made the equipment shall have reached thermal balance in the test chamber. The equipment shall be switched off during the temperature stabilizing period.

In the case of equipment containing temperature stabilization circuits designed to operate continuously, the temperature stabilization circuits may be switched on for 15 minutes after thermal balance has been obtained, and the equipment shall then meet the specified requirements. For such equipment the manufacturer shall provide for the power source circuit feeding the crystal oven to be independent of the power source to the rest of the equipment.

If the thermal balance is not checked by measurements, a temperature stabilizing period of at least one hour shall be allowed. The sequence of measurements shall be chosen, and the humidity content in the test chamber shall be controlled so that excessive condensation does not occur.

6.5.1 Procedure for equipment designed for continuous transmission

If the manufacturer states that the equipment is designed for continuous transmission, the test procedure shall be as follows:

- before tests at the upper extreme temperature the equipment shall be placed in the test chamber and left until thermal balance is attained. The equipment shall then be switched on in the transmit conditions for a period of half an hour after which the equipment shall meet the specified requirements;
- before tests at the lower extreme temperature the equipment shall be left in the test chamber until thermal balance is attained, then switched to the standby or receive condition for a period of one minute after which the equipment shall meet the specified requirements.

6.5.2 Procedure for equipment designed for intermittent transmission

If the manufacturer states that the equipment is designed for intermittent transmission, the test procedure shall be as follows:

- before tests at the upper extreme temperature the equipment shall be placed in the test chamber and left until thermal balance is attained. The equipment shall then be switched on for one minute in the transmit condition, followed by four minutes in the receive condition, after which the equipment shall meet the specified requirements;
- before tests at the lower extreme temperature the equipment shall be left in the test chamber until thermal balance is attained, then switched to the standby or receive condition for one minute after which the equipment shall meet the specified requirements.

7 General conditions of measurement

7.1 Arrangements for test signals at the input of the receiver

Sources of test signals for application to the receiver input shall be connected in such a way that the source impedance presented to the receiver input is 50 Ω non-reactive.

This requirement shall be met irrespective of whether one or more signals using a combining network are applied to the receiver simultaneously.

The levels of the test signals at the receiver input terminals (RF socket) shall be expressed in terms of the emf.

The effects of any intermodulation products and noise produced in the test signal sources shall be negligible.

7.2 Receiver mute or squelch facility

If the receiver is equipped with a mute or squelch circuit, this shall be made inoperative for the duration of the measurements.

7.3 Normal test signals, (wanted and unwanted signals)

The normal test signal D-M3 for initiating responses shall be trains of correctly coded bits or correctly coded signals (messages). For sequential tone coded information, each information (e.g. selective call) shall not be longer than about 400 ms. These test signals D-M3 shall be separated from each other by a time of not less than the reset time of the receiver.

For measurements using the up-down method (see clause 9.2.2) it shall be possible to trigger single test signals D-M3 either manually or by an automatic testing system.

The test signal D-M4 consists of coded signals, messages or tones transmitted sequentially, one by one, without gaps between them. This transmission is necessary for measurements such as adjacent channel power (clause 8.4), spurious emissions (clause 8.5), radiated emissions and others.

All these signals shall be defined such that they require the greatest occupied radio modulation bandwidth. Details of these test signals and the test modulation shall be recorded.

The unwanted signal A-M3 is an RF signal modulated with a continuous 400 Hz tone and with a deviation of 12 % of the channel separation. It is used for measurements such as co-channel rejection (clauses 9.4), adjacent channel selectivity (clauses 9.5) and others.

7.4 Encoder for receiver measurements

Whenever needed and in order to facilitate measurements on the receiver, an encoder for the signalling system shall accompany the equipment, complete with details of the normal modulation process. The encoder shall be used to modulate a signal generator for use as a test signal source.

If possible, the encoder shall be capable of operation in a repetitive mode, with intervals between each code that are not less than the reset time of the receiver.

Complete details of all codes and code format(s) shall be given.

7.5 Test Load (artificial antenna)

For conducted measurements of the transmitter, a power attenuator ("artificial antenna") shall be used, exhibiting a substantially non-reactive, non-radiating load of 50 Ω to the antenna connector and capable of dissipating the transmitter output power.

7.6 Test sites and general arrangements for radiated measurements

For guidance on radiation test sites see annex A. Detailed descriptions of the radiated measurement arrangements are included in annex A.

7.7 Transmitter automatic shut-off facility (time-out)

If the equipment is fitted with an automatic transmitter shut-off facility, it shall be made inoperative for the duration of the test. The operation of the equipment shall not exceed the duty cycle stated by the manufacturer.

7.8 Modes of operation of the transmitter

For the purpose of the measurements according to the present document, there shall preferably be a facility to operate the transmitter in an unmodulated state.

The method of achieving an unmodulated carrier, or special types of modulation patterns, may also be decided by the manufacturer. It may involve suitable temporary internal modifications of the equipment under test.

7.9 Facilities for access between the receiver demodulator output and its decoder

When possible, in order to simplify the measurement in clauses 9.3 and 9.6 a temporary access between the receiver demodulator output and its decoder input shall be provided for the equipment to be tested.

By that means the measurements in clauses 9.3 and 9.6 can be more efficiently carried out using the methods of measurement of ETSI EN 300 086 [3] (see clauses 7.2 and 7.6) to determine the points of interest and then to make measurements at those points using the methods of the present document.

7.10 Calling indicator

Any suitable means of indicating that the receiver has responded to a correctly coded input signal may be used.

7.11 Reset

The reset may be a manual or automatic method of cancelling the calling indication and resetting the decoder, enabling it to respond to the next correctly coded input signal.

7.12 Reset time

The reset time of the receiver is the minimum elapsed time between two calls in order that they may both be successfully registered. The reset time shall be declared by the manufacturer in order that the formation of the normal test signal may be derived.

7.13 Test of equipment with a duplex filter

If the equipment is provided with a built-in duplex filter or a separate associated filter, the requirements of the present document shall be met when the measurements are carried out using the antenna connector of this filter.

8 Technical characteristic of the transmitter

8.1 Frequency error

8.1.0 Applicability

This measurement need not be carried out if this parameter has already been measured according to the requirements of ETSI EN 300 086 [3].

This measurement is made if the equipment is capable of producing an unmodulated carrier. Otherwise the adjacent channel power shall also be measured under extreme test conditions and the appropriate limits given in clause 8.4.3 shall be met.

8.1.1 Definition

The frequency error of the transmitter is the difference between the measured carrier frequency in the absence of modulation and the nominal frequency of the transmitter.

8.1.2 Method of measurement

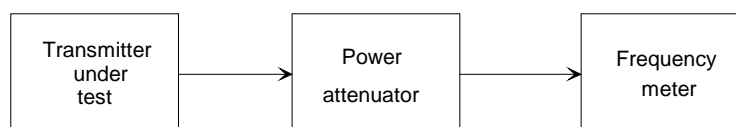

Figure 1: Measurement arrangement

The carrier frequency shall be measured in the absence of modulation with the transmitter connected to a test load (clause 7.5).

The measurement shall be made under normal test conditions, clause 6.3, and repeated under extreme test conditions, clauses 6.4.1 and 6.4.2 applied simultaneously.

8.1.3 Limits

If an unmodulated carrier cannot be obtained, the adjacent channel power shall also be measured under extreme test conditions and the limits given in clause 8.4.3 shall be met.

The frequency error shall not exceed the values given in table 2 under normal, extreme or any intermediate set of conditions. For practical reasons the measurements will be performed only under normal and extreme test conditions as defined in clause 8.1.

Table 2: Frequency error

Channel separation (kHz)	Frequency error limits (kHz)				
	Below 47 MHz	47 MHz to 137 MHz	Above 137 MHz to 300 MHz	Above 300 MHz to 500 MHz	Above 500 MHz to 1 000 MHz
20 and 25	±0,60	±1,35	±2,00	±2,00 (a)	±2,50 (a)
12,5	±0,60	±1,00	±1,00 (B) ±1,50 (M)	±1,00 (B) ±1,50 (a,M)	no value specified

NOTE: B = base station
M = mobile or handportable station
(a) for handportable stations having integral power supplies, the figures given in the table with the suffix (a) only apply to the reduced extreme temperature range 0 °C to + 30 °C.
However, for the full extreme temperature conditions (see clause 6.4.1), exceeding the reduced extreme temperature range, the following frequency error limits apply:

- ±2,50 kHz between 300 and 500 MHz;
- ±3,00 kHz between 500 and 1 000 MHz.

8.2 Carrier power (conducted)

8.2.0 Applicability

This measurement need not be carried out if this parameter has already been measured according to the requirements of ETSI EN 300 086 [3].

If the equipment is designed to operate with different carrier powers, the rated power for each level or range of levels shall be declared by the manufacturer. The power adjustment control shall not be accessible to the user.

The requirements of the present document shall be met for all power levels at which the transmitter is intended to operate. For practical reasons measurements shall be performed only at the lowest and the highest power level at which the transmitter is intended to operate.

8.2.1 Definitions

The transmitter carrier power (conducted, normal conditions) is the mean power delivered to a 50 Ω load during a radio frequency cycle.

The rated output power is the carrier power (conducted) of the equipment declared by the manufacturer.

8.2.2 Method of measurement

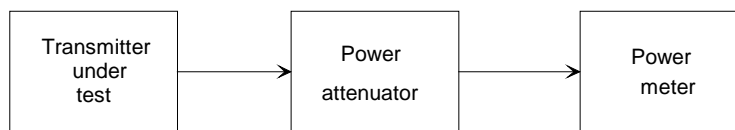

Figure 2: Measurement arrangement

The measurement shall be performed preferably in the absence of modulation.

When it is not possible to measure it in the absence of modulation, this fact shall be recorded (see clause 7.8).

The transmitter shall be connected to a test load (clause 7.5), and the power delivered to this test load shall be measured.

The measurements shall be made under normal test conditions, (clause 6.3), and extreme test conditions, (clauses 6.4.1 and 6.4.2 applied simultaneously).

8.2.3 Limits

The carrier output power (conducted) under the specified conditions of measurement, (see clause 8.2.2) shall be within $\pm 1,5$ dB of the rated output power (conducted).

The carrier output power (conducted) under extreme test conditions shall be within +2,0 dB and -3,0 dB of the rated output power.

8.3 Effective radiated power (field strength)

8.3.0 Applicability

This measurement need not be carried out if this parameter has already been measured according to the requirements of ETSI EN 300 086 [3].

This measurement applies only to equipment without an external antenna connector.

If the equipment is designed to operate with different carrier powers, the rated power for each level, or range of levels, shall be declared by the manufacturer. The power adjustment control shall not be accessible to the user.

The requirements of the present document shall be met for all power levels at which the transmitter is intended to operate. For practical reasons measurements shall be performed only at the lowest and the highest power level at which the transmitter is intended to operate.

8.3.1 Definition

The effective radiated power is the power radiated in the direction of the maximum field strength under specified conditions of measurement.

The rated effective radiated power is the effective radiated power of the equipment as declared by the manufacturer.

8.3.2 Method of measurement

This measurement applies only to equipment without an external 50 Ω antenna connection.

The measurement shall be carried out under normal test conditions only (see clause 6.3).

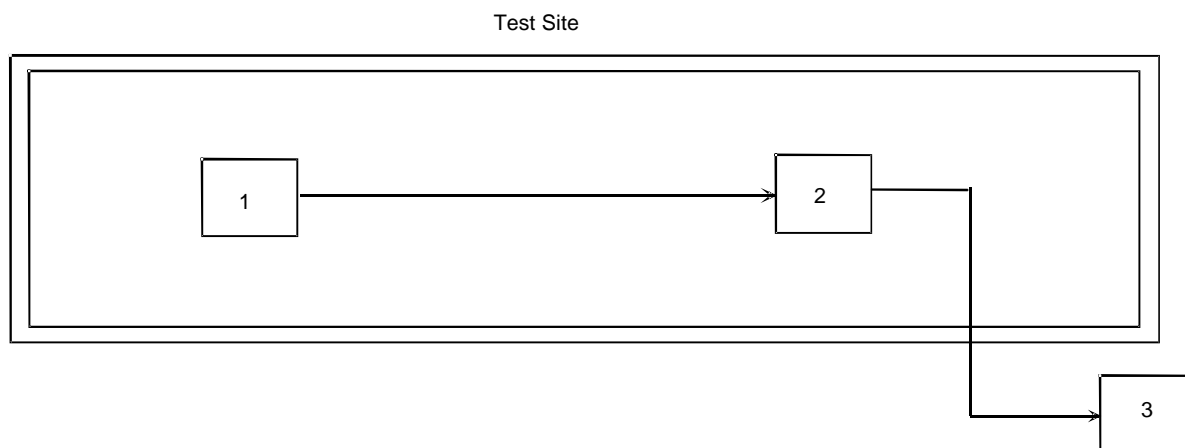

- 1) Transmitter under test.
- 2) Test antenna.
- 3) Spectrum analyser or selective voltmeter (test receiver).

Figure 3: Measurement arrangement

The measurement shall be performed preferably in the absence of modulation.

When it is not possible to measure the effective radiated power in the absence of modulation this fact shall be recorded (see clause 7.8).

The procedure shall be as follows:

- a) A test site, selected from annex A, which fulfils the requirements of the specified frequency range of this measurement shall be used. The test antenna shall be oriented initially for vertical polarization unless otherwise stated:
 - the transmitter under test shall be placed at the specified height on a non-conducting support and in the position closest to normal use as declared by the manufacturer. This position shall be recorded.
- b) The spectrum analyser or selective voltmeter shall be tuned to the transmitter carrier frequency. The test antenna shall be raised or lowered through the specified height range until the maximum signal level is detected on the spectrum analyser or selective voltmeter:
 - the test antenna need not be raised or lowered if the measurement is carried out on a test site according to clause A.1.1 (i.e. an anechoic chamber).
- c) The transmitter shall be rotated through 360° about a vertical axis until a higher maximum signal is received.
- d) The test antenna shall be raised or lowered again through the specified height range until a maximum is obtained. This level shall be recorded. (This maximum may be a lower value than the value obtainable at heights outside the specified limits):
 - the test antenna need not be raised or lowered if the measurement is carried out on a test site according to clause A.1.1 (i.e. an anechoic chamber).

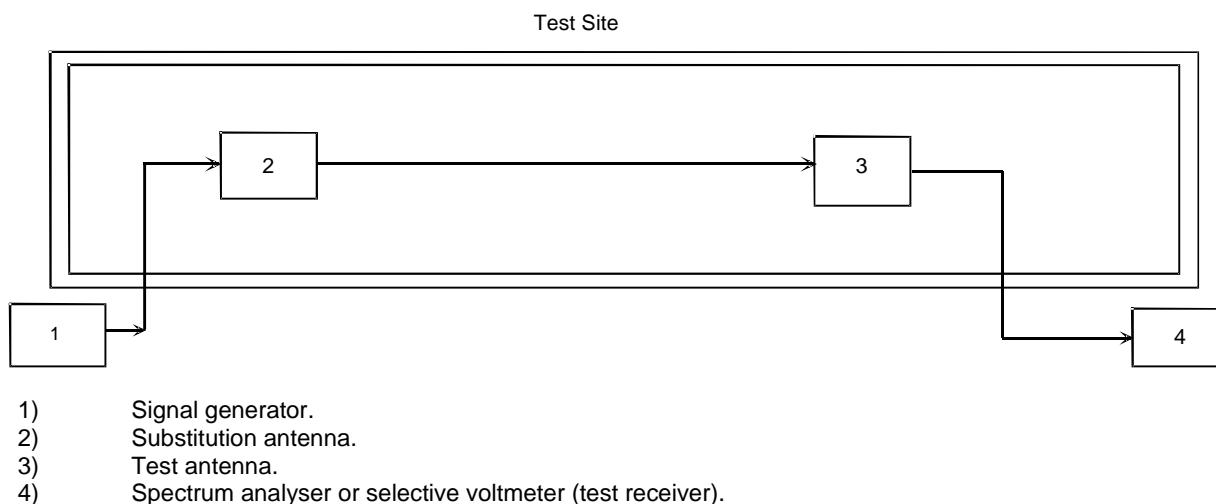

Figure 4: Measurement arrangement

- e) Using the measurement arrangement of figure 4, the substitution antenna (clause A.1.5) shall replace the transmitter antenna in the same position and in vertical polarization. The frequency of the signal generator shall be adjusted to the transmitter carrier frequency. The test antenna shall be raised or lowered as necessary to ensure that the maximum signal is still received:
- the test antenna need not be raised or lowered if the measurement is carried out on a test site according to clause A.1.1 (i.e. an anechoic chamber);
 - the input signal to the substitution antenna shall be adjusted in level until an equal or a known related level to that detected from the transmitter is obtained in the test receiver. The maximum carrier radiated power is equal to the power supplied by the signal generator, increased by the known relationship if necessary, and after corrections due to the gain of the substitution antenna and the cable loss between the signal generator and the substitution antenna.
- f) Steps b) to e) above shall be repeated with the test antenna and the substitution antenna orientated in horizontal polarization.

The measure of the effective radiated power is the larger of the two power levels recorded at the input to the substitution antenna, corrected for the gain of the antenna if necessary.

8.3.3 Limits

The effective radiated power under normal test conditions shall be within d_f from the rated effective radiated power.

The allowance for the characteristics of the equipment ($\pm 1,5$ dB) shall be combined with the actual measurement uncertainty in order to provide d_f as follows:

$$d_f^2 = d_m^2 + d_e^2$$

where:

- d_m is the actual measurement uncertainty;
- d_e is the allowance for the equipment (1,5 dB);
- d_f is the final difference.

All values shall be expressed in linear terms.

In all cases the actual measurement uncertainty shall comply with clause 11.

Furthermore, the maximum effective radiated power shall not exceed the maximum value allowed by the Administrations.

Example calculation of d_f :

$d_m = 6$ dB (value acceptable, as indicated in the table of maximum uncertainties);

$= 3,98$ in linear terms;

$d_e = 1,5$ dB (fixed value for all equipment fulfilling the requirements of the present document);

$= 1,41$ in linear terms;

$d_f^2 = (3,98)^2 + (1,41)^2$;

Therefore, $d_f = 4,22$ in linear terms or $6,25$ dB.

This calculation shows that in this case d_f exceeds d_m , the actual measurement uncertainty (6 dB) by 0,25 dB.

8.4 Adjacent and alternate channel power

8.4.0 Applicability

This measurement shall be carried out whether or not the equipment has previously been tested to the requirements of ETSI EN 300 086 [3].

8.4.1 Definition

The adjacent channel power is that part of the total output power of a transmitter under defined conditions of modulation, which falls within a specified passband centred on the nominal frequency of either of the adjacent channels. This power is the sum of the mean power produced by the modulation, hum and noise of the transmitter.

8.4.2 Method of measurement

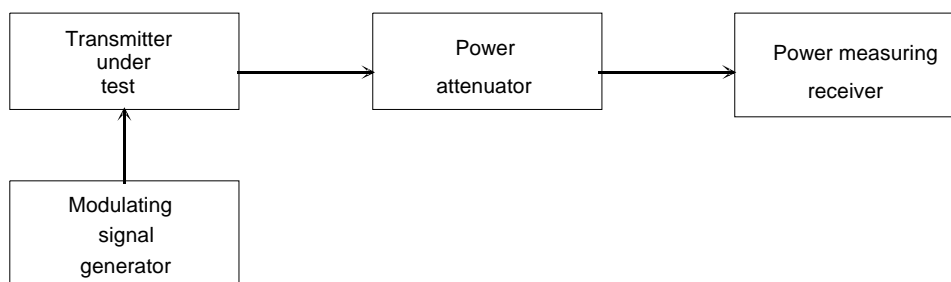

Figure 5: Measurement arrangement

The measurement procedure shall be as follows.

The power measuring receiver used shall conform to the requirements given in annex B, (referred to in this clause as the "receiver"):

- a) The transmitter shall be operated at the carrier power determined in clause 8.2 under normal test conditions (see clause 6.3). The output of the transmitter shall be connected to the input of the "receiver" by a connecting device such that the impedance presented to the transmitter is 50Ω and the level at the "receiver" input is appropriate.

- b) With the transmitter unmodulated, the tuning of the "receiver" shall be adjusted so that a maximum response is obtained. This is the 0 dB reference point. The "receiver" variable attenuator setting and the reading of the rms value indicator shall be recorded. If an unmodulated carrier cannot be obtained then the measurement shall be made with the transmitter modulated with test signal D-M4 (see clause 7.3) in which case this fact shall be recorded.
- c) The frequency of the "receiver" shall be adjusted above the carrier so that the "receiver" -6 dB response nearest to the transmitter carrier frequency is located at a displacement from the nominal carrier frequency as given in table 3.

Table 3: Frequency displacement

Channel separation (kHz)	Specified necessary bandwidth (kHz)	Adjacent channel displacement of the -6 dB point from the nominal carrier frequency (kHz)	Alternate channel displacement of the -6 dB point from the nominal carrier frequency (kHz)
12,5	8,5	8,25	20,75
20	14	13	33
25	16	17	42

- d) The transmitter shall be modulated by the test signal D-M4 (see clause 7.3). If the equipment is intended to operate with combined analogue speech and signalling then the transmitter shall also be modulated by a test signal of 1 250 Hz at a level which is 20 dB higher than that required to produce 60 % of the maximum permissible frequency deviation.
- e) The "receiver" variable attenuator shall be adjusted to obtain the same reading as in step b) or a known relation to it.
- f) The ratio of adjacent channel power to carrier power is the difference between the attenuator settings in steps b) and e), corrected for any differences in the reading of the indicator.
- g) The measurement shall be repeated with the frequency of the "receiver" adjusted below the carrier so that the "receiver" -6 dB response nearest to the transmitter carrier frequency is located at a displacement from the nominal carrier frequency as given in table 3.
- h) The test shall be repeated for the alternate channels.

When it is not possible to perform the measurement of frequency error in the absence of modulation (see clause 8.1), the measurement shall be repeated under extreme test conditions (clauses 6.4.1 and 6.4.2 applied simultaneously).

Alternatively, if a spectrum analyser is being used (see clause B.2) that is capable of measuring rms adjacent channel power automatically, the adjacent channel power (in dB) may be measured directly with the transmitter modulated by normal test signal D-M4, according to clause 7.3. The spectrum analyser shall use a measurement method without frequency weighting and shall not use an accelerated method. The adjacent channel power ratio is the value of the measurement results showing the smallest difference between the power in the pass-band and the power in either adjacent channel.

For automated spectrum analyser measurements the following settings shall be used:

- resolution bandwidth: 500 Hz;
- video bandwidth: 5 000 Hz;
- video average: off;
- detector mode: rms.

Up to 100 individual reading may be averaged, however video average shall not be used.

8.4.3 Limits

For a channel separation of 12,5 kHz, 20 kHz and 25 kHz, the adjacent channel power and the alternate channel power shall not exceed a value of 60,0 dB below the transmitter power (conducted) without the need to be below 0,2 μW (-37 dBm).

For channel separations of 20 kHz and 25 kHz, the alternate channel power shall not exceed a value of 70,0 dB below the carrier power (conducted) of the transmitter without the need to be below 0,20 μW (-37 dBm). For a channel separation of 12,5 kHz, the alternate channel power shall not exceed a value of 60 dB below the transmitter carrier power without the need to be below 0,20 μW (-37 dBm).

In the case where the equipment is not capable of producing an unmodulated carrier these measurements shall also be performed under extreme test conditions except where equipment has already been tested to the requirements of ETSI EN 300 086 [3]. Under these extreme test conditions the measured adjacent channel power shall not exceed a value of 65 dB below the carrier for equipment with channel separations of 20 kHz and 25 kHz and 55 dB for channel separations of 12,5 kHz, without the need to be below 0,20 μW .

8.5 Transmitter spurious emissions

8.5.0 Applicability

This measurement shall be carried out subject to the provisions of clause 4.

8.5.1 Definition

Spurious emissions are emissions at frequencies other than those of the carrier and sidebands associated with normal test modulation.

The level of spurious emissions shall be measured as: either:

- a) their power level in a specified load (conducted spurious emission); and
- b) their effective radiated power when radiated by the cabinet and structure of the equipment (cabinet radiation); or
- c) their effective radiated power when radiated by the cabinet and the integral antenna, in the case of handportable equipment fitted with such an antenna and no external RF connector.

8.5.2 Method of measuring the power level

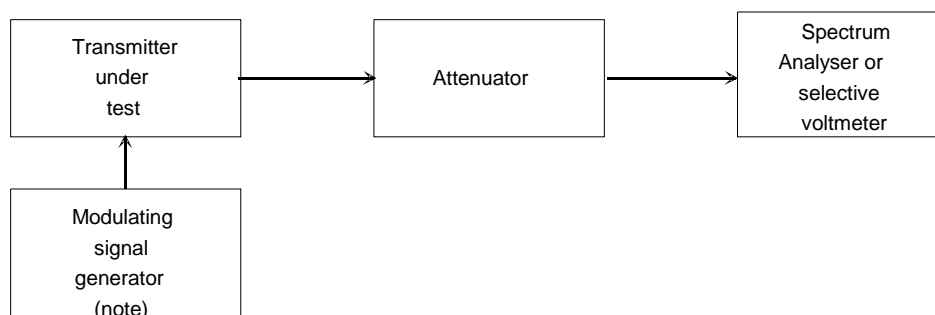

NOTE: Used only if it is not possible to perform the measurement with the transmitter unmodulated.

Figure 6: Measurement arrangement

This method applies only to equipment with an external antenna connector.

Spurious emissions shall be measured as the power level of any discrete signal (excluding the wanted signal) delivered into a 50 Ω load. This may be done by connecting the transmitter output through an attenuator to a spectrum analyser (clause B.2) or selective voltmeter, or by monitoring the relative levels of the spurious signals diverted to an artificial load (clause 7.5).

If possible, the measurement shall be made with the transmitter unmodulated. If this is not possible, the transmitter shall be modulated by the normal test signal D-M4 as appropriate (clause 7.3). If possible the modulation shall be continuous for the duration of the measurement.

As a general rule, the resolution bandwidth of the measuring receiver should be equal to the reference bandwidth:

"To improve measurement accuracy, sensitivity and efficiency, the resolution bandwidth can be different from the reference bandwidth. When the resolution bandwidth is smaller than the reference bandwidth, the result should be integrated over the reference bandwidth. When the resolution bandwidth is greater than the reference bandwidth, the result for broadband spurious emissions should be normalized to the bandwidth ratio. For discrete spur, normalization is not applicable, while integration over the reference bandwidth is still applicable." (extract from CEPT/ERC/REC 74-01 [i.6], recommend 4, page 5).

The conditions used in the relevant measurements shall be recorded.

The measurements shall be made, for the equipment operating on frequencies not exceeding 470 MHz, in the frequency range 9 kHz to 4 GHz, and for equipment operating on frequencies above 470 MHz, additionally in the frequency range 4 GHz to 12,75 GHz, except for the channel on which the transmitter is intended to operate, and its adjacent channels.

The measurement shall be repeated with the transmitter in the "stand-by" position.

8.5.3 Method of measuring the effective radiated power

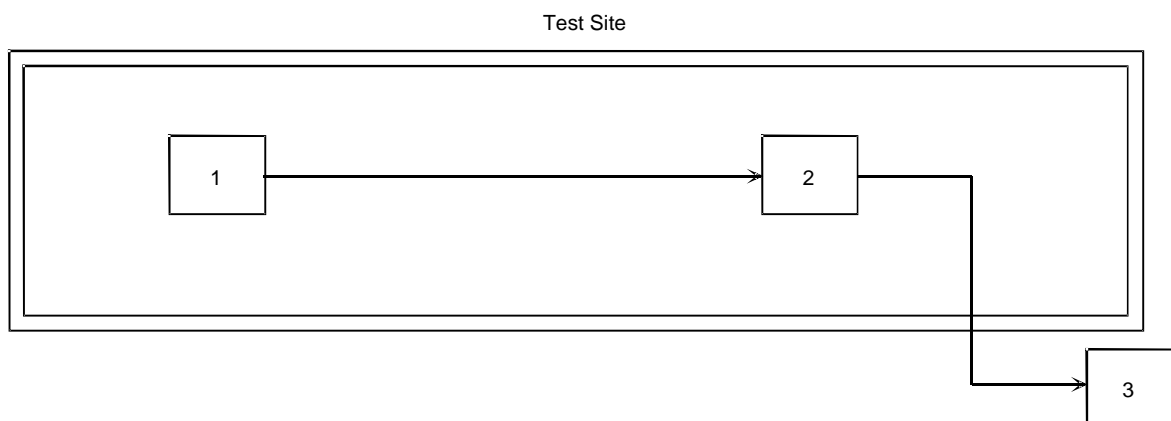

- 1) Transmitter under test.
- 2) Test antenna.
- 3) Spectrum analyser or selective voltmeter (test receiver).

Figure 7: Measurement arrangement

The measurement procedure shall be as follows:

- a) On a test site fulfilling the requirements of clause A.1, the sample shall be placed at the specified height on the support. The transmitter shall be operated at the carrier power as specified under clause 8.2, delivered to:
 - an artificial antenna (clause 7.5) for equipment having an external antenna connector (clause 8.5.1, b); or
 - to the integral antenna (clause 8.5.1, c).

- b) If possible the measurement shall be made with the transmitter unmodulated. If this is not possible, the transmitter shall be modulated by the normal test signal D-M2 or D-M4 as appropriate (clause 7.3). If possible the modulation shall be continuous for the duration of the measurement:
- As a general rule, the resolution bandwidth of the measuring receiver should be equal to the reference bandwidth.

"To improve measurement accuracy, sensitivity and efficiency, the resolution bandwidth can be different from the reference bandwidth. When the resolution bandwidth is smaller than the reference bandwidth, the result should be integrated over the reference bandwidth. When the resolution bandwidth is greater than the reference bandwidth, the result for broadband spurious emissions should be normalized to the bandwidth ratio. For discrete spur, normalization is not applicable, while integration over the reference bandwidth is still applicable." (extract from CEPT/ERC/REC 74-01 [i.6], recommend 4, page 5).
 - The conditions used in the relevant measurement shall be recorded.
- c) The radiation of any spurious components shall be detected by the test antenna and receiver, over the frequency range 30 MHz to 4 GHz, except for the channel on which the transmitter is intended to operate and its adjacent channels.

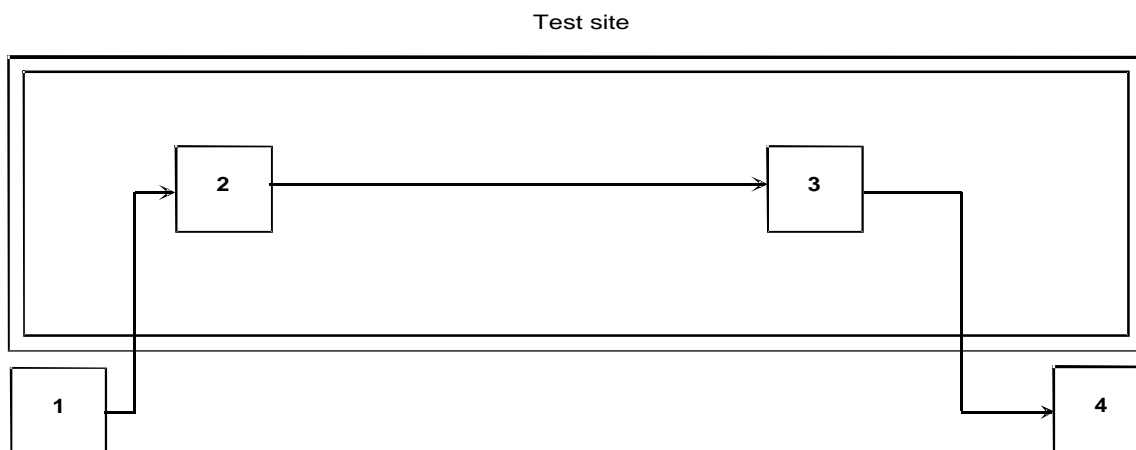

- 1) Signal generator.
- 2) Substitution antenna.
- 3) Test antenna.
- 4) Spectrum analyser or selective voltmeter (test receiver).

Figure 8: Measurement arrangement

- d) At each frequency at which a component is detected, the sample shall be rotated to obtain maximum response and the effective radiated power of that component determined by a substitution measurement, using the measurement arrangement of figure 8.
- e) The measurement shall be repeated with the test antenna in the orthogonal polarization plane.
- f) The measurement shall be repeated with the transmitter in the "stand-by" position.

8.5.4 Transmitter spurious emissions

The power of any spurious emission shall not exceed the values given in tables 4 and 5a.

Table 4: Conducted emissions

Frequency range	Tx operating	Tx standby
9 kHz to 1 GHz	0,25 μ W (-36 dBm)	2,0 nW (-57 dBm)
1 GHz to 4 GHz, or 1 GHz to 12,75 GHz (clause 8.5.2)	1,00 μ W (-30 dBm)	20 nW (-47 dBm)

Table 5a: Radiated emissions

Frequency range	Tx operating	Tx standby
30 MHz to 1 GHz	0,25 μ W (-36 dBm)	2,0 nW (-57 dBm)
1 GHz to 4 GHz	1,00 μ W (-30 dBm)	20 nW (-47 dBm)

In the case of radiated measurements for handportable stations the following conditions apply:

- for equipment with an internal integral antenna: the normal antenna shall remain connected;
- for equipment with an external antenna socket: an artificial load shall be connected to the socket for the test.

The reference bandwidths used shall be as stated in tables 5b and 5c.

Table 5b: Reference bandwidths to be used for the measurement of spurious emission

Frequency range	RBW
30 MHz to 1 GHz	100 kHz
1 GHz to 12,75 GHz	1 MHz

Table 5c: Reference bandwidths to be used close to the wanted emission

Frequency offset from carrier	RBW
250 % of the CSP to 100 kHz	1 kHz
100 kHz to 500 kHz	10 kHz

8.6 Intermodulation attenuation

8.6.0 Applicability

This requirement applies only to transmitters to be used as base stations (fixed).

This measurement need not be carried out if this parameter has already been measured according to the requirements of ETSI EN 300 086 [3].

8.6.1 Definition

For the purpose of the present document, the intermodulation attenuation is a measure of the capability of a transmitter to avoid the generation of signals within its non-linear elements caused by the presence of the carrier and an interfering signal entering the transmitter via the antenna.

It is specified as the ratio, in dB, of the carrier power level to the level of the third order intermodulation product.

8.6.2 Method of measurement

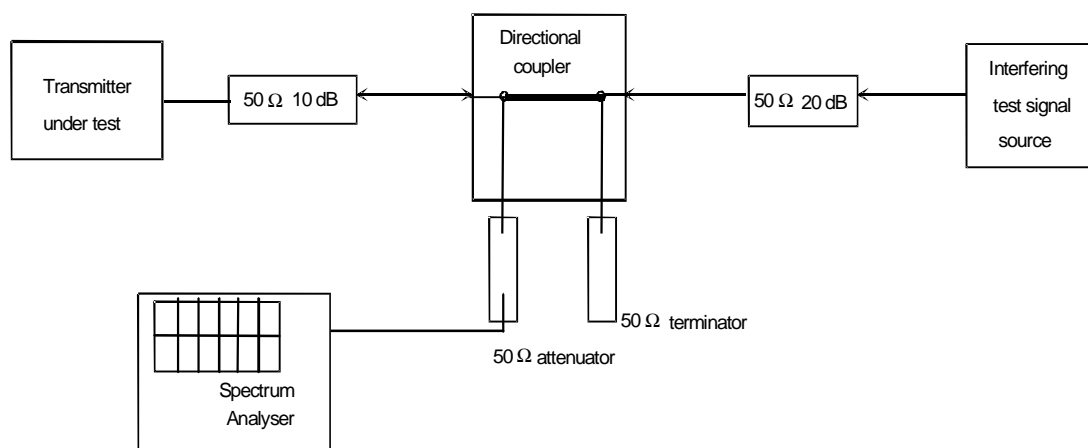

Figure 9: Measurement arrangement

The measurement procedure shall be as follows.

The measurement arrangement shown in figure 9 shall be used.

The transmitter shall be connected to a 50 Ω 10 dB power attenuator and via a directional coupler to a spectrum analyser. An additional attenuator may be required between the directional coupler and the spectrum analyser to avoid overloading.

In order to reduce the influence of mismatch errors it is important that the 10 dB power attenuator is coupled to the transmitter under test with the shortest possible connection.

The interfering signal source may be either a transmitter providing the same power output as the transmitter under test and be of a similar type, or a signal generator and a linear power amplifier capable of delivering the same output power as the transmitter under test.

The (directional) coupler shall have an insertion loss of less than 1 dB, a sufficient bandwidth and a directivity of at least 20 dB.

The transmitter under test and the test signal source shall be physically separated in such a way that the measurement is not influenced by direct radiation.

The transmitter under test shall be unmodulated and the spectrum analyser adjusted to give a maximum indication of the wanted signal with a frequency scan width of 500 kHz.

The interfering test signal source shall be unmodulated and the frequency shall be within 50 kHz to 100 kHz above the frequency of the transmitter under test.

The frequency shall be chosen in such a way that the intermodulation components to be measured do not coincide with other spurious components. The power output of the interfering test signal source shall be adjusted to the carrier power level of the transmitter under test by the use of a power meter.

The intermodulation component shall be measured by direct observation on the spectrum analyser of the ratio of the largest third order intermodulation component with respect to the carrier.

This measurement shall be repeated with the interfering test signal source at a frequency within 50 kHz to 100 kHz below the frequency of the transmitter under test.

If an unmodulated carrier cannot be obtained then the measurement shall be made with the transmitter modulated by the test signal D-M4 (see clause 7.3) in which case this fact shall be recorded.

8.6.3 Limits

Two classes of transmitter intermodulation attenuation are defined, the equipment shall fulfil one of the requirements as follows:

- in general the intermodulation attenuation ratio shall be at least 40,0 dB for any intermodulation component;
- for base stations to be used in special service conditions (e.g. at sites where more than one transmitter will be in service) or when the regulatory authority makes it a condition of the licence, the intermodulation attenuation ratio shall be at least 70,0 dB for any intermodulation component. In the case where the performance is achieved by additional internal or external isolating devices (such as circulators) these shall be available at the time of testing and shall be used for the measurements.

8.7 Transmitter Attack Time

8.7.0 Applicability

This measurement does not apply to transmitters intended for continuous transmission only.

This measurement need not be carried out if this parameter has already been measured according to the requirements of ETSI EN 300 086 [3].

8.7.1 Definition

The transmitter attack time (t_a) is the time which elapses between the initiation of the "transmitter on" function (Tx_{on} , time at which the final irrevocable logic decision to power on the transmitter is taken) and:

- a) the moment when the transmitter output power has reached a level 1 dB below or 1,5 dB above the steady state power (P_c) and maintains a level within +1,5 dB/-1 dB from P_c thereafter as seen on the measuring equipment or in the plot of power as a function of time; or
- b) the moment after which the frequency of the carrier always remains within ± 1 kHz of its steady state frequency, F_c , as seen on the measuring equipment or the plot of frequency as a function of time;

whichever occurs later.

The measured value of t_a is t_{am} ; its limit is t_{al} .

The choice of conditions for b) above (± 1 kHz and not the frequency tolerance of the steady state, df_c), is made in order to make the method of measurement easier to perform and to have good repeatability. It is expected that under these conditions, in the worst case, the frequency of the carrier will be within the frequency tolerance of the steady state, df_c , a few ms after the end of the attack time as defined in b) above.

8.7.2 Method of measurement

For the test arrangement see clause 8.9.2, figure 10.

NOTE: Where a test discriminator is specified in the following clauses a frequency deviation meter may be used instead.

The measurement procedure shall be as follows:

- a) the transmitter is connected to a RF detector and to a test discriminator via a matched test load. The attenuation of the test load shall be chosen in such a way that the input of the test discriminator is protected against overload and the limiter amplifier of the test discriminator operates correctly in the limiting range as soon as the transmitter carrier power (before attenuation) exceeds 1 mW. A dual trace storage oscilloscope (or a

transient recorder) records the amplitude transient from the detector on a logarithmic scale and the frequency transient from the discriminator:

- a trigger device may be required to ensure that the start of the sweep of the oscilloscope time base occurs at the instant at which the "transmitter on" function is initiated. The measuring arrangement is shown in figure 10 of clause 8.9.2;
 - a spectrum analyser and a test discriminator/storage oscilloscope can also be used;
- b) the traces of the oscilloscope shall be calibrated in power and frequency (y-axis) and in time (x-axis), using the signal generator;
 - c) the transmitter attack time shall be measured by direct reading on the oscilloscope while the transmitter is preferably unmodulated.

8.7.3 Limits

The transmitter attack time shall not exceed 25 ms ($t_{am} \leq t_{al}$).

8.8 Transmitter release time

8.8.0 Applicability

This measurement does not apply to transmitters intended for continuous transmission only.

This measurement need not be carried out if this parameter has already been measured according to the requirements of ETSI EN 300 086 [3].

8.8.1 Definition

The transmitter release time (t_r) is the time which elapses between the initiation of the "transmitter off" function ($T_{x,off}$, time at which the final irrevocable logic decision to power off the transmitter is taken) and the moment when the transmitter output power has reduced to a level 50 dB below the steady state power (P_c) and remains below this level thereafter as seen on the measuring equipment or in the plot of power as a function of time.

The measured value of t_r is t_{rm} ; its limit is t_{rl} .

8.8.2 Method of measurement

For the test arrangement see clause 8.9.2, figure 10.

The measurement procedure shall be as follows:

- a) the transmitter is connected to a RF detector and to a test discriminator via a matched power attenuator. Its attenuation shall be chosen in such a way that the input of the test discriminator is protected against overload and that the limiter amplifier of the test discriminator operates correctly in the limiting range as long as the transmitter carrier power (before attenuation) exceeds 1 mW. A dual trace storage oscilloscope (or a transient recorder) records the amplitude transient from the detector on a logarithmic scale and the frequency transient from the discriminator. A trigger device may be required to ensure that the start of the sweep of the oscilloscope timebase occurs the instant at which the "transmitter off" function is initiated. If the transmitter possesses an automatic powering down facility (e.g. in the case of fixed length message transmission), it may replace the trigger device for starting the sweep of the oscilloscope. The measuring arrangement is shown in figure 10 of clause 8.9.2:
 - a spectrum analyser and a test discriminator/storage oscilloscope can also be used;
- b) the traces of the oscilloscope shall be calibrated in power and frequency (y-axes) and in time (x-axis) by replacing the transmitter and test load by the signal generator;

- c) the transmitter release time shall be measured by direct reading on the oscilloscope while the transmitter is preferably unmodulated.

8.8.3 Limits

The transmitter release time shall not exceed 20 ms ($t_{rm} \leq t_{r1}$).

8.9 Transient frequency behaviour of the transmitter

8.9.0 Applicability

This measurement does not apply to equipment designed for continuous transmission only.

This measurement need not be carried out if this parameter has already been measured according to the requirements of ETSI EN 300 086 [3].

8.9.1 Definitions

The transient behaviour of the transmitter is defined as the time dependency of the transmitter frequency when the RF output power is switched on and off.

- t_{on} : According to the method of measurement described in clause 8.9.2 the switch-on instant t_{on} of a transmitter is defined by the condition when the output power, measured at the antenna terminal, exceeds 0,1 % of the nominal power.
- t_1 : Period of time starting at t_{on} and finishing according to table 6 (see clause 8.9.3).
- t_2 : Period of time starting at the end of t_1 and finishing according to table 6 (see clause 8.9.3).
- t_{off} : Switch-off instant defined by the condition when the output power falls below 0,1 % of the nominal power.
- t_3 : Period of time finishing at t_{off} and starting according to table 6 (see clause 8.9.3).

8.9.2 Method of measurement

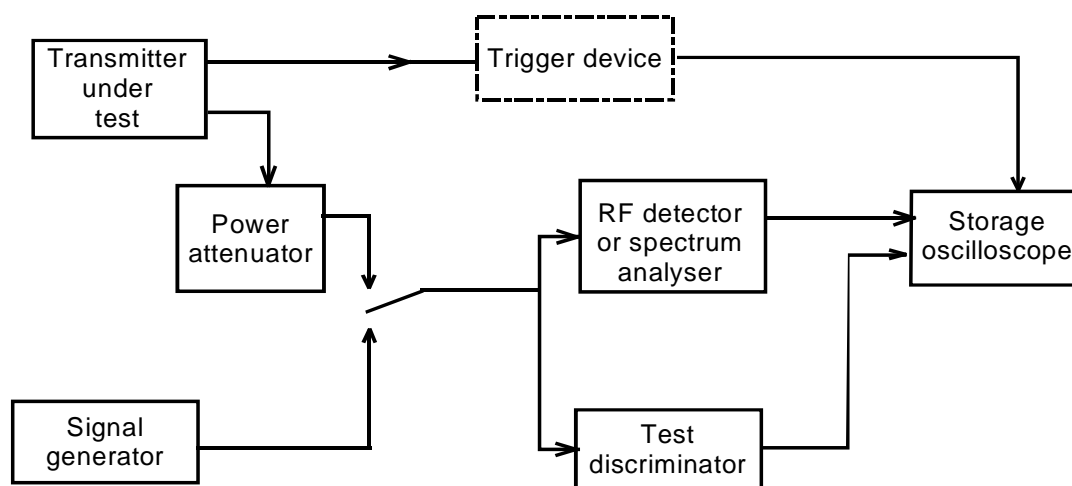

Figure 10a: Test arrangement for transient behaviour of transmitter power and frequency, including transmitter attack and release time

The measurement procedure shall be as follows.

The measurement arrangement shown in figure 10b shall be used.

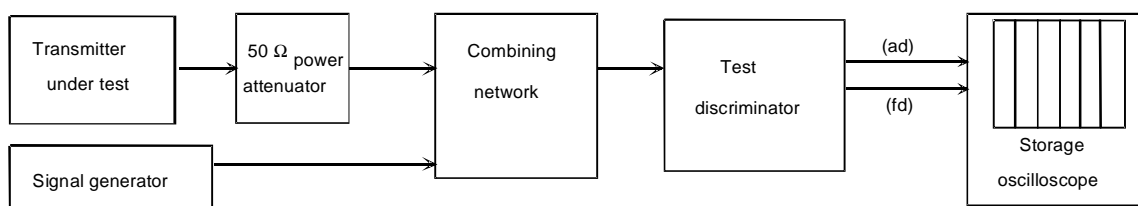

Figure 10b: Measurement arrangement including a combining network

Two signals shall be connected to the test discriminator via a combining network (see clause 7.1).

The transmitter shall be connected to a 50 Ω power attenuator.

The output of the power attenuator shall be connected to the test discriminator via one input of the combining network.

A test signal generator shall be connected to the second input of the combining network.

The test signal shall be adjusted to the nominal frequency of the transmitter.

The test signal shall be modulated by a frequency of 1 kHz with a deviation equal to \pm the value of the relevant channel separation.

The test signal level shall be adjusted to correspond to 0,1 % of the power of the transmitter under test measured at the input of the test discriminator. This level shall be maintained throughout the measurement.

The amplitude difference (ad) and the frequency difference (fd) output of the test discriminator shall be connected to a storage oscilloscope.

The storage oscilloscope shall be set to display the channel corresponding to the (fd) input up to ± 1 channel frequency difference, corresponding to the relevant channel separation, from the nominal frequency.

The storage oscilloscope shall be set to a sweep rate of 10 ms/div and set so that the triggering occurs at 1 div from the left edge of the display. The display will show the 1 kHz test signal continuously.

The storage oscilloscope shall then be set to trigger on the channel corresponding to the amplitude difference (ad), that is the level of 0,1 % of the power of the tested transmitter for a rising input level.

The transmitter shall then be switched on, without modulation, to produce the trigger pulse and a picture on the display.

The result of the change in the ratio of power between the test signal and the transmitter output will, due to the capture ratio of the test discriminator, produce two separate sides on the picture, one showing the 1 kHz test signal, the other the frequency difference of the transmitter versus time.

The moment when the 1 kHz test signal is completely suppressed is considered to provide t_{on} .

The periods of time t_1 and t_2 as defined in table 6, see clause 8.9.3, shall be used to define the appropriate template.

During the period of time t_1 and t_2 the frequency difference shall not exceed the values given in clause 8.9.3.

The frequency difference, after the end of t_2 , shall be within the limit of the frequency error (see clause 8.1.3).

The result shall be recorded as frequency difference versus time.

The transmitter shall remain switched on.

The storage oscilloscope shall be set to trigger on the channel corresponding to the amplitude difference (ad) input at a high input level, decaying and set so that the triggering occurs at 1 div. from the right edge of the display.

The transmitter shall then be switched off.

The moment when the 1 kHz test signal starts to rise is considered to provide t_{off} .

The period of time t_3 as defined in table 6, clause 8.9.3, shall be used to define the appropriate template.

During the period of time t_3 the frequency difference shall not exceed the values given in figure 11.

Before the start of t_3 the frequency difference shall be within the limit of the frequency error, clause 8.1.3.

The result shall be recorded as frequency difference versus time.

If an unmodulated carrier cannot be obtained then the measurements shall be made with the transmitter modulated by the test signal D-M4 (see clause 7.3) and an extra $\frac{1}{2}$ channel separation will be accepted for the limit of the peak frequency difference.

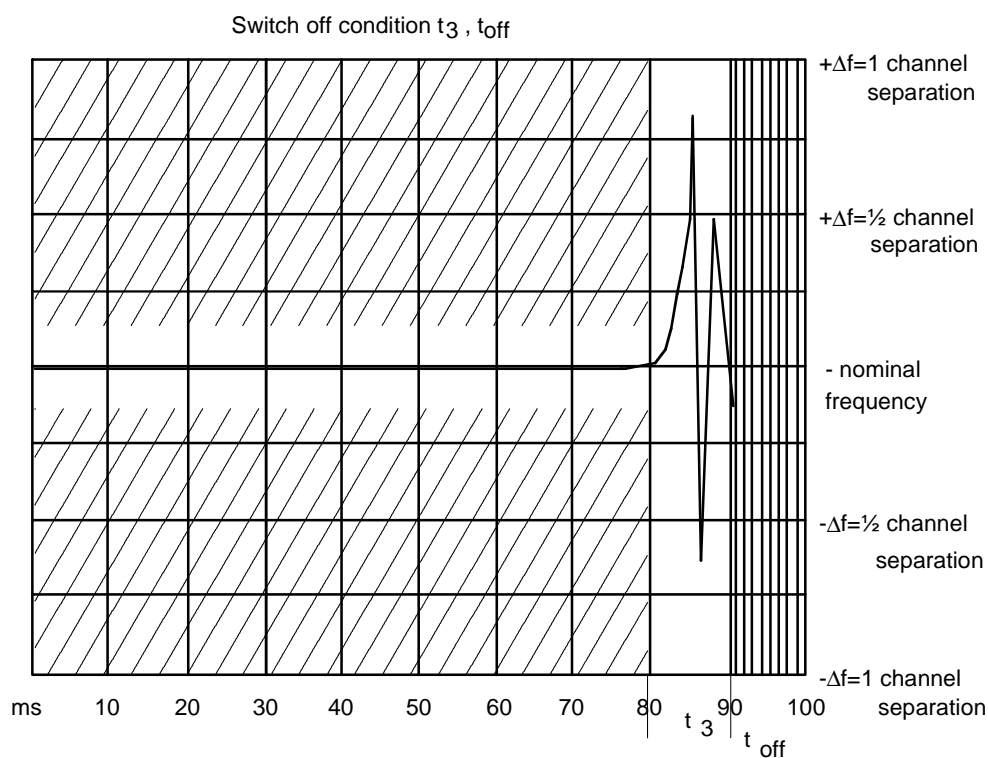
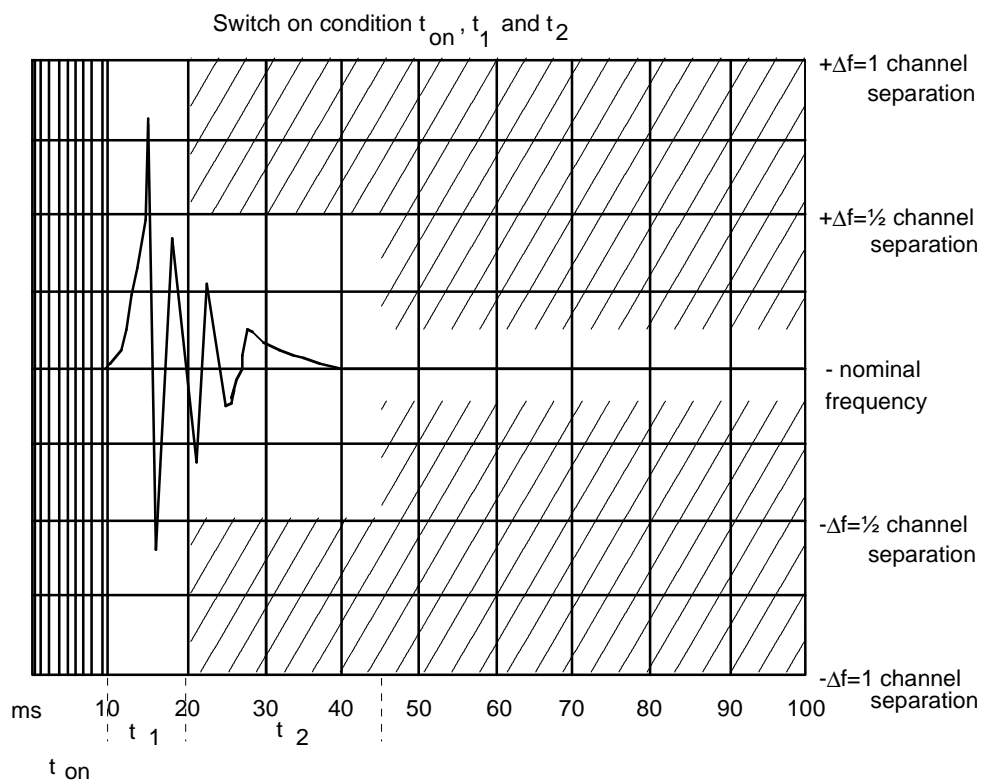

NOTE: The figures show the oscilloscope display with 10 ms/division horizontal. Refer to clause 5.1.9 for the actual values of t_1 , t_2 and t_3 .

Figure 11: Storage oscilloscope view t_1 , t_2 and t_3

8.9.3 Limits

The transient periods are given in table 6. The transient periods for the frequency range > 300 MHz to 500 MHz are shown as an example in figure 11, clause 8.9.

Table 6: Transient periods

	30 MHz to 300 MHz	300 MHz to 500 MHz	500 MHz to 1 000 MHz
t1 (ms)	5,0	10,0	20,0
t2 (ms)	20,0	25,0	50,0
t3 (ms)	5,0	10,0	10,0

During the periods t1 and t3 the frequency difference shall not exceed the value of 1 channel separation.

During the period t2 the frequency difference shall not exceed the value of half a channel separation.

In the case of equipment where an unmodulated carrier cannot be obtained, an additional $\frac{1}{2}$ channel separation will be accepted for the limit of the peak frequency difference, during t1, t2 and t3.

9 Technical characteristics of the receiver

9.1 Reference sensitivity (responses)

9.1.1 Definition

In the case of degradation measurements, the following definition of reference sensitivity is used.

The reference sensitivity (responses) of the receiver is the level of a signal, to be provided at the receiver input terminals as emf or as field strength, by a generator operating at the nominal frequency of the receiver and modulated with the normal test signal (see clause 7.3), which will be used as a reference for the degradation measurements. Its level is given in clause 9.1.2.

9.1.2 Reference sensitivity (response)

The reference sensitivity (response) for normal test conditions is a level of +6 dB μ V emf or a field strength 3 dB above the limit values found in clause 9.3.5.

9.2 Maximum usable sensitivity (responses, conducted)

9.2.0 Applicability

This measurement shall be carried out whether or not the equipment has previously been tested to the requirements of ETSI EN 300 086 [3].

9.2.1 Definition

The maximum usable sensitivity (responses, conducted) of the receiver is the minimum level of signal (emf) at the receiver input, produced by a carrier at the nominal frequency of the receiver, modulated with the normal test signal D-M3 (see clause 7.3), which will, without interference, produce after demodulation a specified successful response ratio.

The specified response ratio is 80 %.

9.2.2 Method of measurement ("up-down method")

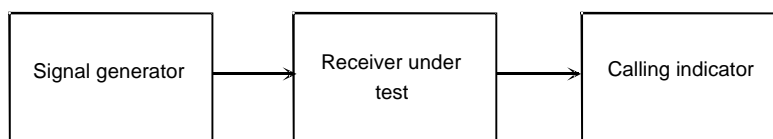

Figure 12: Measurement arrangement

The measurement procedure shall be as follows:

- a) an input signal with a frequency equal to the nominal frequency of the receiver, modulated by the normal test signal D-M3 (clause 7.3) shall be applied to the receiver input terminals;
- b) the level of this signal shall be such that a successful response rate of less than approximately 10 % is obtained;
- c) the normal test signal D-M3 shall be transmitted repeatedly whilst observing in each case whether or not a successful response is obtained:
 - the input level shall be increased by 2 dB for each occasion that a successful response is not obtained;
 - the procedure shall be continued until three consecutive successful responses are observed;
 - the level of the input signal shall be noted;
- d) the input signal shall be reduced by 1 dB and the new value noted:
 - the normal test signal D-M3 shall then be transmitted 20 times;
 - in each case, if a response is **not** obtained the input level shall be increased by 1 dB and the new value noted;
 - if a successful response is obtained, the input level shall not be changed until three consecutive successful responses have been obtained;
 - in this case, the input level shall be reduced by 1 dB and the new value noted;
 - no input signal levels shall be noted unless preceded by a change in level;
- e) the maximum usable sensitivity is the average of the values noted in steps c) and d); (which provides the level corresponding to the successful response ratio of 80 %). This value shall be recorded;
- f) the measurement shall be made under normal test conditions (clause 6.3) and repeated under extreme test conditions (clauses 6.4.1 and 6.4.2 applied simultaneously).

9.2.3 Limits

The maximum usable sensitivity shall not exceed an emf of +3 dB μ V under normal test conditions, and an emf of +9 dB μ V under extreme test conditions.

9.3 Average usable sensitivity (field strength, responses)

9.3.0 Applicability

This measurement applies only to equipment without an external antenna connector.

9.3.1 Definition

The average usable sensitivity (responses) expressed as field strength is the average field strength, expressed in dB μ V/m, produced by a carrier at the nominal frequency of the receiver, modulated with the normal test signal D-M3 (see clause 7.3) which will, without interference, produce after demodulation a specified successful response ratio. The average is calculated from 8 measurements of field strength when the receiver is rotated in 45° increments starting at a particular orientation.

NOTE: The average usable sensitivity mostly differs only by a small amount from the maximum usable sensitivity to be found in a particular direction. This is due to the properties of the averaging process as used in the formula in clause 9.3.2 j). For instance, an error not exceeding 1,2 dB can be found if the sensitivity is equal in seven directions and is extremely bad in the eighth direction. For the same reason the starting direction (or angle) can be selected randomly.

9.3.2 Method of measurement under normal test conditions

Arrangements shall be made to couple the equipment under test to the calling indicator by a method, which does not affect the radiated field (see annex A, clause A.3).

A test site, which fulfils the requirements of the specified frequency range of this measurement, shall be used. The test antenna shall be orientated for vertical polarization or for the polarization in which the equipment under test is intended to operate.

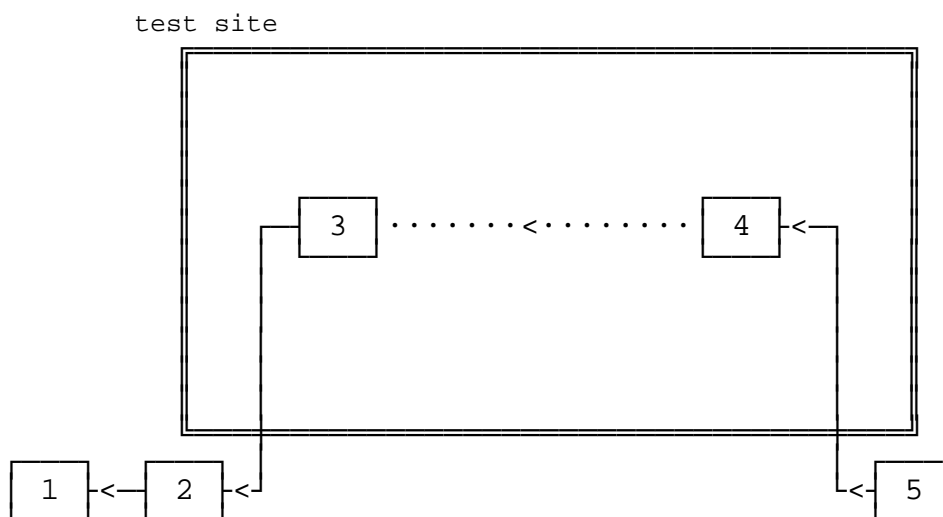

NOTE: 1) Calling indicator.
2) Photo detector/acoustic coupler.
3) Receiver under test.
4) Test antenna.
5) Signal generator.

Figure 13: Measurement arrangement

- a) A signal generator shall be connected to the test antenna.

The signal generator shall be at the nominal frequency of the receiver and shall be modulated with normal test signal D-M3.

The receiver under test shall be placed on the support in its standard position and in a random orientation. A calling indicator shall be connected to the receiver, preferably via a photo detector or an acoustic coupler (see annex A, clause A.3) in order to avoid disturbing the electromagnetic field in the vicinity of the equipment.

- b) The level of the signal generator shall be adjusted until a successful response ratio of less than approximately 10 % is obtained.

- c) The test antenna shall be raised or lowered through the specified height range to find the maximum response ratio.

The level of the test signal shall be re-adjusted to produce the response ratio specified in step b).

The test antenna need not be raised or lowered if the measurement is carried out on a test site according to annex A, clause A.1.1 (i.e. an anechoic chamber).

- d) Note the minimum signal generator level from step b) or c) as appropriate.
- e) The normal test signal shall be transmitted repeatedly whilst observing in each case whether or not a successful response is obtained.

The level of the test signal shall be increased by 2 dB for each occasion that a successful response is not obtained. The procedure shall be continued until three consecutive responses are observed.

NOTE: This level is the minimum signal generator level in this direction.

- f) The level noted in step e) shall be reduced by 1 dB and the new value also noted. The normal test signal D-M3 shall then be transmitted 20 times. In each case, if a response is not obtained, the level shall be increased by 1 dB and the new value noted. If a successful response is obtained, the level shall not be changed until three consecutive successful responses have been observed. In this case, the level shall be reduced by 1 dB and the new value noted. No signal level shall be noted unless preceded by a change in level.

The average of the values noted corresponds to the successful response ratio of 80 %. It shall be used to calculate the field strength associated with each position in step h).

- g) Steps b) to f) above shall be repeated for the remaining seven positions (45° apart) of the receiver, and the corresponding average values of the generator output (corresponding to successful response ratios of 80 %) shall be determined and recorded.
- h) Using the relationship described in annex A, calculate and record the eight field strengths X_i in $\mu\text{V/m}$ corresponding to the above average values.
- i) The average sensitivity expressed as field strength E_{mean} (dB $\mu\text{V/m}$) is given by:

$$E_{\text{mean}} = 20 \log \left(\sqrt{\frac{8}{\sum_{i=1}^8 \frac{1}{X_i^2}}} \right)$$

where X_i represents each of the eight field strengths calculated in step h). The recorded result is the average usable sensitivity expressed in dB $\mu\text{V/m}$.

- j) The reference direction is defined as the direction at which the maximum sensitivity level (i.e. the minimum field strength for the responses noted during the measurement) occurred in the eight measuring positions.

The corresponding direction, height (where applicable) and this reference field strength value shall be recorded.

9.3.3 Method of measurement of the average usable sensitivities under extreme test conditions

Using the test fixture in the measurement arrangement of figure 14, the measurement of the average usable sensitivity shall also be performed under extreme test conditions.

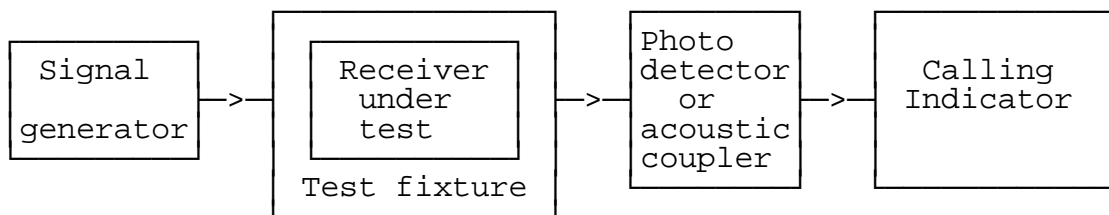

Figure 14: Measurement arrangement

The test signal input level providing a successful response ratio of 80 % shall be determined under extreme and under normal test conditions and the difference in dB shall be calculated. This difference shall be added to the average measured usable sensitivity to radiated fields expressed in $\text{dB}\mu\text{V}/\text{m}$, as calculated in clause 9.3.2 j), under normal test conditions, to obtain the sensitivity under extreme test conditions.

9.3.4 References for degradation measurements

9.3.4.1 Definition

Degradation measurements are those measurements made on the receiver to establish the degradation of the performance of the receiver due to the presence of an unwanted (interfering) signal. For such measurements, the level of the unwanted signal shall be adjusted to a level, which is 3 dB above the limit of the average usable sensitivity.

Degradation measurements fall into two categories:

- a) those carried out on a test site;
- b) those carried out using a test fixture.

The test fixture is only used for those tests where the difference in frequency between the wanted and unwanted test signals is very small in relation to the actual frequency, so that the coupling loss is the same for the wanted and unwanted test signals fed into the test fixture.

9.3.4.2 Procedures for measurements using the test fixture

The test fixture is coupled to the signal generators via a combining network to provide the wanted and unwanted test input signals to the receiver in the test fixture. It is necessary therefore to establish the output level of the wanted test signal from the signal generator that results in a signal at the receiver (in the test fixture) which corresponds with the average usable sensitivity (radiated) as specified in clause 9.3.5.

This test output level from the signal generator for the wanted test signal is then used for all the receiver measurements using the test fixture.

The method for determining the test output level from the signal generator is as follows:

- a) the actual average usable sensitivity of the receiver is measured in accordance with clause 9.3.2 j) and expressed as a field strength;
- b) the difference between the limit of the average usable sensitivity specified in clause 9.3.5, and this actual average usable sensitivity, expressed in dB, is noted;
- c) the receiver is then mounted in the test fixture;

the signal generator providing the wanted input signal is coupled to the test fixture via a combining network. All other input ports of the combining network are terminated in $50\ \Omega$ loads;

the output from the signal generator with normal test modulation D-M3 (see clause 7.3) is adjusted so that the successful response ratio of 80 % is obtained (see clause 9.1.2 f)). This output level is then increased by an amount equal to the difference expressed in dB calculated in clause 9.3.4.2 b);

the output level of the signal generator A is defined as being the level equivalent to the limit of the average usable sensitivity, for the category of equipment used, expressed as a field strength (see clause 9.3.5).

9.3.4.3 Procedures for measurements using the test site

When measurements are carried out on a test site, the wanted and unwanted signals shall be calibrated in terms of dB μ V/m at the location of the equipment under test.

For measurements according to clauses 9.6, 9.8 and annex A, the height of the test antenna and the direction (angle) of the equipment under test shall be that recorded in clause 9.3.2 j) (reference direction).

9.3.5 Limits

For the average usable sensitivity limits, four categories of equipment are defined as follows:

- Category A: equipment having an integral antenna fully within the case;
- Category B: equipment having an extractable or fixed integral antenna, with an antenna length not exceeding 20 cm external to the case;
- Category C: equipment having an extractable or fixed integral antenna, with an antenna length exceeding 20 cm external to the case;
- Category D: equipment not covered by category A, B or C.

Under normal test conditions, the average usable sensitivity shall not exceed the following field strength values.

Table 7a: Sensitivity limits for Categories A and D

Frequency band (MHz)	Average usable sensitivity in dB relative to 1 μ V/m
30 to 400	27,0
> 400 to 750	28,5
> 750 to 1 000	30,0

Table 7b: Sensitivity limits for Category B

Frequency band (MHz)	Average usable sensitivity in dB relative to 1 μ V/m
30 to 130	18,0
> 130 to 300	19,5
> 300 to 440	21,5
> 440 to 600	23,5
> 600 to 800	25,5
> 800 to 1 000	28,0

Category C:

At frequencies greater than 375 MHz the limits shall be as specified in table 7b.

In the case of frequencies less than or equal to 375 MHz a correction factor K, shall be subtracted from the specified field strengths in table 7b:

$$- K = 20 \log_{10} [(1+20)/40];$$

where l is the external part of the antenna in cm.

This correction only applies if the antenna length external to the case is less than $(15\,000/f_0 - 20)$ in cm, where f_0 is the frequency in MHz (applicable to frequencies below 375 MHz).

For all categories of equipment, add 6 dB to the limit under normal test conditions to obtain the limit under extreme test conditions.

9.4 Co-channel rejection

9.4.0 Applicability

This measurement need not be carried out if this parameter has already been measured according to the requirements of ETSI EN 300 086 [3].

9.4.1 Definition

The co-channel rejection is a measure of the capability of the receiver to achieve a specific successful response ratio when receiving the wanted signal in the presence of an unwanted modulated signal, both signals being at the nominal frequency of the receiver.

9.4.2 Method of measurement

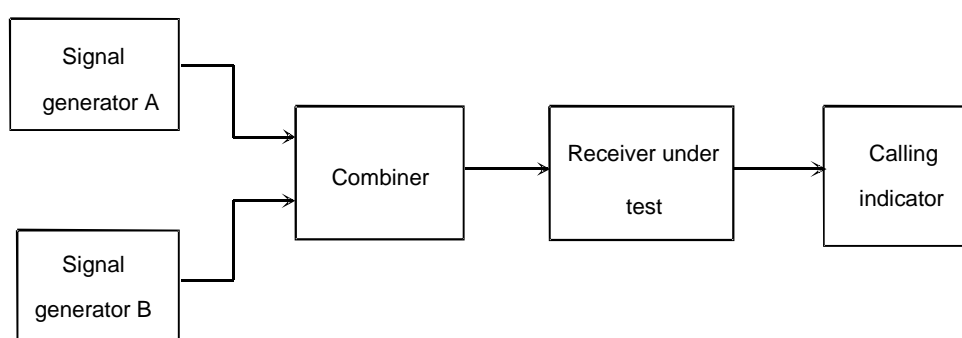

Figure 15: Measurement arrangement

The measurement procedure shall be as follows:

- a) two signal generators A and B shall be connected to the receiver via a combining network (see clause 7.1):
 - the wanted signal, provided by signal generator A, shall have normal test modulation D-M3 (see clause 7.3);
 - the unwanted signal, provided by signal generator B, shall be modulated with signal A-M3 (see clause 7.3);
 - both input signals shall be at the nominal frequency of the receiver under test;
- b) initially, signal generator B (the unwanted signal) shall be switched off (maintaining the output impedance):
 - the level of the wanted signal from generator A shall be adjusted to a level which is 3 dB above the level of the maximum usable sensitivity as specified in clause 9.2, at the receiver input terminals (i.e. 6 dB above 1 μ V emf under normal test conditions);
- c) signal generator B shall then be switched on, and the level of the unwanted signal adjusted until a successful response ratio of less than approximately 10 % is obtained;
- d) the normal test signal D-M3 shall be transmitted repeatedly whilst observing in each case whether or not a successful response is obtained:
 - the level of the unwanted signal shall be reduced by 2 dB for each occasion that a successful response is not obtained;
 - the procedure shall be continued until three consecutive successful responses are observed;
 - the level of the input signal shall then be noted;
- e) the level of the unwanted signal shall be increased by 1 dB and the new value noted:

- the normal test signal D-M3 shall then be transmitted 20 times;
 - in each case, if a response is not obtained the level of the unwanted signal shall be reduced by 1 dB and the new value noted;
 - if a successful response is obtained the level of the unwanted signal shall not be changed until three consecutive successful responses have been obtained. In this case, the unwanted signal shall be increased by 1 dB and the new value noted;
 - no level of the unwanted signal level shall be noted unless preceded by a change in level;
 - the average of the values in steps d) and e) (which provide the level corresponding to the successful response ratio of 80 %) shall be noted;
- f) for each frequency of the unwanted signal, the co-channel rejection ratio shall be expressed as the ratio, in dB, of the average level noted in step e) to the level of the wanted signal, at the receiver input:
- this ratio shall be recorded;
- g) the measurement shall be repeated for displacements of the unwanted signal of $\pm 12\%$ of the channel separation;
- h) the co-channel rejection ratio of the equipment under test shall be expressed as the lowest of the three values expressed in dB, calculated in step f):
- the limit corresponding to this parameter may be found in clause 9.4.3;
 - the value of the co-channel rejection ratio, expressed in dB, is generally negative (therefore, for example, -12 dB is lower than -8 dB).

9.4.3 Limits

The value of the co-channel rejection ratio, expressed in dB, at the signal displacements given in the method of measurement shall be:

- between -8,0 dB and 0 dB for channel separations of 20 kHz and 25 kHz;
- between -12,0 dB and 0 dB for channel separation of 12,5 kHz.

9.5 Adjacent channel selectivity

9.5.0 Applicability

This measurement need not be carried out if this parameter has already been measured according to the requirements of ETSI EN 300 086 [3].

9.5.1 Definition

The adjacent channel selectivity is a measure of the capability of the receiver to achieve a specific successful response ratio when receiving a wanted modulated signal in the presence of an unwanted modulated signal which differs in its frequency from the wanted signal by an amount equal to the adjacent channel separation for which the equipment is intended.

9.5.2 Method of measurement

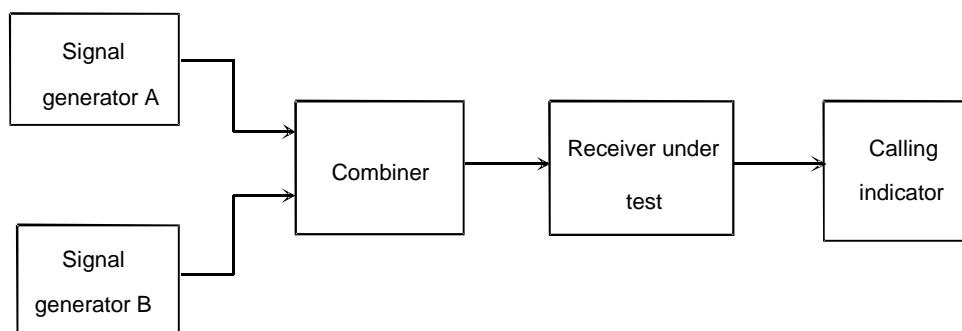

Figure 16: Measurement arrangement

The measurement procedure shall be as follows:

- a) two signal generators A and B shall be connected to the receiver under test via a combining network:
 - the wanted signal, provided by signal generator A, shall be at the nominal frequency of the receiver and shall have normal test modulation D-M3 (see clause 7.3);
 - the unwanted signal, provided by signal generator B, shall be modulated with signal A-M3 (see clause 7.3) and shall be at the frequency of the channel immediately above that of the wanted signal;
- b) initially signal generator B (the unwanted signal) shall be switched off (maintaining its output impedance):
 - the level of the wanted signal from generator A shall be adjusted to a level which is 3 dB above the level of the maximum usable sensitivity, as specified in clause 9.2 at the receiver input terminals (i.e. 6 dB above 1 μ V emf under normal test conditions);
- c) signal generator B shall then be switched on, and the level of the unwanted signal adjusted until a successful response ratio of less than 10 % is obtained;
- d) the normal test signal D-M3 shall be transmitted repeatedly whilst observing in each case whether or not a successful response is obtained:
 - the level of the unwanted signal shall be reduced by 2 dB for each occasion that a successful response is not obtained;
 - the procedure shall be continued until three consecutive successful responses are observed. The level of the input signal shall then be noted;
- e) the level of the unwanted signal shall be increased by 1 dB and the new value noted:
 - the normal test signal D-M3 shall then be transmitted 20 times. In each case, if a response is not obtained the level of the unwanted signal shall be reduced by 1 dB and the new value noted;
 - if a successful response is obtained, the level of the unwanted signal shall not be changed until three consecutive successful responses have been obtained. In this case the unwanted signal shall be increased by 1 dB and the new value noted;
 - no level of the unwanted signal shall be noted unless preceded by a change in level;
 - the average of the values noted in steps d) and e) (which provides the level corresponding to the successful response ratio of 80 %) shall be noted;
- f) for each adjacent channel, the selectivity shall be expressed as the ratio in dB of the average level noted in step e) to the level of the wanted signal this value shall be recorded;
- g) the measurement shall be repeated with the unwanted signal at the frequency of the channel below that of the wanted signal;

- h) the adjacent channel selectivity of the equipment under test shall be expressed as the lower of the two values measured in the upper and lower channel nearest to the receiving channel (see step f) above);
- i) the measurement shall be repeated under extreme test conditions (clauses 6.4.1 and 6.4.2 applied simultaneously), using the level of the wanted signal, as specified in clause 9.2 increased by 6 dB.

9.5.3 Limits

The adjacent channel selectivity for different channel separations shall not be less than the values given in table 8.

Table 8: Adjacent channel selectivity

	Channel separation	
	12,5 kHz	20/25 kHz
Normal test conditions	60,0 dB	70,0 dB
Extreme test conditions	50,0 dB	60,0 dB

9.6 Spurious response rejection

9.6.0 Applicability

This measurement need not be carried out if this parameter has already been measured according to the requirements of ETSI EN 300 086 [3].

Spurious responses may occur at all frequencies throughout the frequency spectrum and the requirements of the present document shall be met, by the equipment, for all frequencies. However, for practical reasons measurements shall be performed as specified in the present document. More specifically, this method of measurement is not intended to capture all spurious responses but selects those that have a high probability of being present. However, in a limited frequency range close to the nominal frequency of the receiver, it has been considered impossible to determine the probability of a spurious response and therefore a search shall be performed over this limited frequency range. This method provides a high degree of confidence that the equipment also meets the requirements at other frequencies.

9.6.1 Definition

The spurious response rejection is a measure of the capability of the receiver to receive a wanted modulated signal without exceeding a given degradation due to the presence of an unwanted modulated signal at any other frequency, at which a response is obtained.

9.6.2 Introduction to the method of measurement

To determine the frequencies at which spurious responses can occur the following calculations shall be made:

- a) Calculation of the "limited frequency range":
 - the limited frequency range is defined as the frequency of the local oscillator signal (f_{LO}) applied to the first mixer of the receiver plus or minus the sum of the intermediate frequencies (f_{I1}, \dots, f_{In}) and half the switching range (sr) of the receiver (clause 4);
 - hence, the frequency f_l of the limited frequency range is bounded as follows:

$$f_{LO} - \sum_{j=1}^{j=n} f_{Ij} - \frac{sr}{2} \leq f_l \leq f_{LO} + \sum_{j=1}^{j=n} f_{Ij} + \frac{sr}{2}$$

- b) calculation of frequencies outside the limited frequency range:
 - a calculation of the frequencies at which spurious responses can occur outside the range determined in a) is made for the remainder of the frequency range of interest, as appropriate (clauses 9.6.4 and 9.6.5);

- the frequencies outside the limited frequency range are equal to the harmonics of the frequency of the local oscillator signal (f_{LO}) applied to the first mixer of the receiver plus or minus the first intermediate frequency (f_{I1}) of the receiver;
- hence, the frequencies of these spurious responses are:

$$nf_{LO} \pm f_{I1}$$

- where n is an integer greater than or equal to 2.

The measurement of the first image response of the receiver shall initially be made to verify the calculation of spurious response frequencies.

For the calculations a) and b) above, the manufacturer shall state the frequency of the receiver, the frequency of the local oscillator signal (f_{LO}) applied to the 1st mixer of the receiver, the intermediate frequencies (f_{I1} , f_{I2} etc.), and the switching range (sr) of the receiver.

9.6.3 Method of search over the "limited frequency range"

The search is performed using the temporary access (see clause 7.9).

The measurement procedure shall be as follows:

- a) two signal generators, A and B, shall be connected to the receiver via a combining network (clause 7.1):
 - the wanted signal, provided by signal generator A, shall be at the nominal frequency of the receiver and shall have the normal test signal or modulation (clause 7.3);
 - the unwanted signal, provided by signal generator B, shall be modulated with signal A-M3 (clause 7.3);

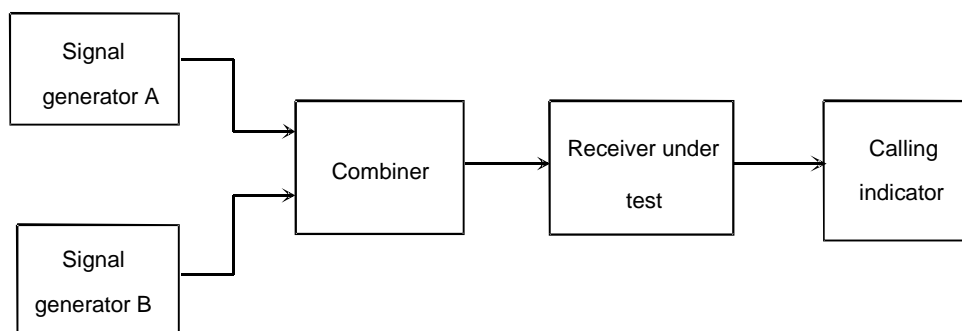

Figure 17: Measurement arrangement

- b) initially, signal generator B (unwanted signal) shall be switched off (maintaining the output impedance):
 - the level of the wanted signal from generator A shall be adjusted to the level which is 3 dB above the level of the limit of the maximum usable sensitivity as specified in clause 9.2 at the receiver input terminals (i.e. 6 dB above 1 μ V emf under normal test conditions);
- c) signal generator B shall then be switched on, and the level of the unwanted signal adjusted to 86 dB μ V at the receiver input terminals:
 - the frequency of the unwanted signal generator shall be varied in increments of 5 kHz over the limited frequency range (clause 9.6.2 a) and over the frequencies in accordance with the calculations outside of this frequency range (clause 9.6.2 b);
- d) the frequency of any spurious response detected (e.g. by a degradation in the previously noted response ratio) during the search shall be recorded for use in the measurements in accordance with clause 9.6.4.

9.6.4 Method of measurement

The measurement procedure shall be as follows. The measurement arrangement shown figure 17 in clause 9.6.3, shall be used:

- a) two signal generators, A and B, shall be connected to the receiver via a combining network (clause 7.1):
 - the wanted signal, provided by signal generator A, shall be at the nominal frequency of the receiver and shall have normal test modulation (clause 7.3);
 - the unwanted signal, provided by signal generator B, shall be modulated with a frequency of 400 Hz and with a deviation of 12 % of the channel separation (A-M3) (clause 7.3), and shall be at the frequency of that spurious response being considered;
- b) initially, signal generator B (the unwanted signal) shall be switched off (maintaining the output impedance):
 - the level of the wanted signal from generator A shall be adjusted to the level which is 3 dB above the level of the limit of the maximum usable sensitivity as specified in clause 9.3.5 (responses, conducted), at the receiver input terminals (i.e. 6 dB above 1 μ V emf under normal test conditions);
- c) signal generator B shall be switched on, and the level of the unwanted signal adjusted until a successful response ratio of less than approximately 10 %;
- d) the normal test signal D-M3 shall be transmitted repeatedly whilst observing in each case whether or not a successful response is obtained:
 - the level of the unwanted signal A-M3 shall be reduced by 2 dB for each occasion that a successful response is not obtained;
 - the procedure shall be continued until three consecutive successful responses are observed;
 - the level of the input signal shall then be noted;
- e) the unwanted input signal level shall be increased by 1 dB and the new value noted:
 - the normal test signal D-M3 shall then be transmitted 20 times. In each case, if a successful response is not obtained the level of the unwanted signal shall be reduced by 1 dB and the new value noted;
 - if a successful response is obtained the level of the unwanted signal shall not be changed until three consecutive successful responses have been obtained;
 - in this case the unwanted signal shall be increased by 1 dB and the new value noted;
 - no levels of the unwanted input signal level shall be noted unless preceded by a change in level;
 - the average values noted in step d) and e) (which provides the level corresponding to the successful response ratio of 80 %) shall be noted;
- f) for each frequency, the spurious response rejection shall be expressed as the ratio, in dB, of the level of the unwanted signal to the level of the wanted signal, at the receiver input:
 - this ratio shall be recorded;
- g) the measurement shall be repeated at all spurious response frequencies found during the search over the "limited frequency range" (see clause 9.6.3) and those frequencies calculated for the remainder of the spurious response frequencies in the frequency range 100 kHz to 2 GHz, for equipment operating on frequencies not exceeding 470 MHz, and over the frequency range of 100 kHz to 4 GHz, for equipment operating on frequencies above 470 MHz;

- h) The spurious response rejection of the equipment under test shall be expressed as the lowest value recorded in step f).

9.6.5 Limits

At any frequency separated from the nominal frequency of the receiver by two channels or more, the spurious response rejection ratio shall not be less than 70,0 dB.

9.7 Intermodulation response

9.7.0 Applicability

This measurement need not be carried out if this parameter has already been measured according to the requirements of ETSI EN 300 086 [3].

9.7.1 Definition

The intermodulation response is a measure of the capability of the receiver to achieve a specific response ratio when receiving a wanted modulated signal in the presence of two or more unwanted signals with a specific frequency relationship to the wanted signal frequency.

9.7.2 Method of measurement

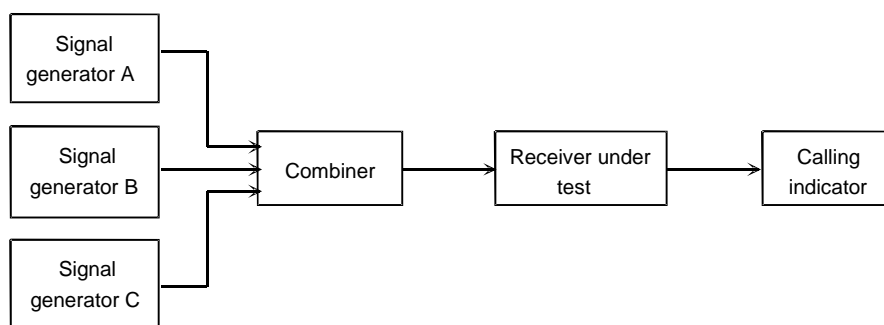

Figure 18: Measurement arrangement

The measurement procedure shall be as follows:

- a) three signal generators, A, B and C shall be connected to the receiver under test via a combining network (see clause 7.1):
 - the wanted signal, provided by signal generator A, shall be at the nominal frequency of the receiver and shall have normal test modulation D-M3 (see clause 7.3);
 - the first unwanted signal, provided by signal generator B, shall be unmodulated and adjusted to the frequency 50 kHz above the nominal frequency of the receiver;
 - the second unwanted signal, provided by signal generator C, shall be modulated with signal A-M3 (see clause 7.3) and adjusted to a frequency 100 kHz above the nominal frequency of the receiver;
- b) initially, signal generators B and C, (the unwanted signals) shall be switched off (maintaining the output impedance):
 - the level of the wanted signal from generator A shall be adjusted to a level which is 3 dB above the level of the maximum usable sensitivity (responses, conducted), as specified in clause 5.2.2 at the receiver input terminals (i.e. 6 dB above 1 μ V emf under normal test conditions);

- c) signal generators B and C shall then be switched on; the levels of the two unwanted signals shall be maintained equal and shall be adjusted until a successful response ratio of less than approximately 10 % are obtained;
- d) the normal test signal D-M3 shall be transmitted repeatedly whilst observing in each case whether or not a successful response is obtained:
 - the levels of the unwanted signals shall be reduced by 2 dB for each occasion that a successful response is not obtained;
 - the procedure shall be continued until three consecutive successful responses are observed. The level of the input signals shall then be noted;
- e) the level of the unwanted signals shall be increased by 1 dB and the new value noted:
 - the normal test signal D-M3 shall then be transmitted 20 times. In each case, if a response is not obtained the level of the unwanted signals shall be reduced by 1 dB and the new value noted;
 - if a successful response is obtained, the input level of the unwanted signals shall not be changed until three consecutive successful responses have been obtained. In this case the level of the unwanted signals shall be increased by 1 dB and the new value noted;
 - no level of the unwanted signal shall be noted unless preceded by a change in level;
 - the average of the values noted in steps d) and e) (which provides the level corresponding to the successful response ratio of 80 %) shall be noted;
- f) for each configuration of the unwanted signals (defined in g), the intermodulation response rejection shall be expressed as the ratio in dB of the average level recorded in step e) to the level of the wanted signal:
 - this ratio shall be recorded;
- g) the measurement shall be repeated with the unwanted signal generator B at the frequency 50 kHz below that of the wanted signal and the frequency of the unwanted signal generator C at the frequency 100 kHz below that of the wanted signal;
- h) the intermodulation response rejection of the equipment under test shall be expressed as the lower of the two values calculated in step f).

9.7.3 Limits

The intermodulation response rejection ratio shall not be less than 70,0 dB for base stations and 65,0 dB for mobile and handportable equipment.

9.8 Blocking or desensitization

9.8.0 Applicability

This measurement need not be carried out if this parameter has already been measured according to the requirements of ETSI EN 300 086 [3].

9.8.1 Definition

Blocking is a measure of the capability of the receiver to achieve a specific successful response ratio when receiving the wanted signal in the presence of an unwanted unmodulated high level signal on frequencies other than those of spurious responses or adjacent channels.

9.8.2 Method of measurement

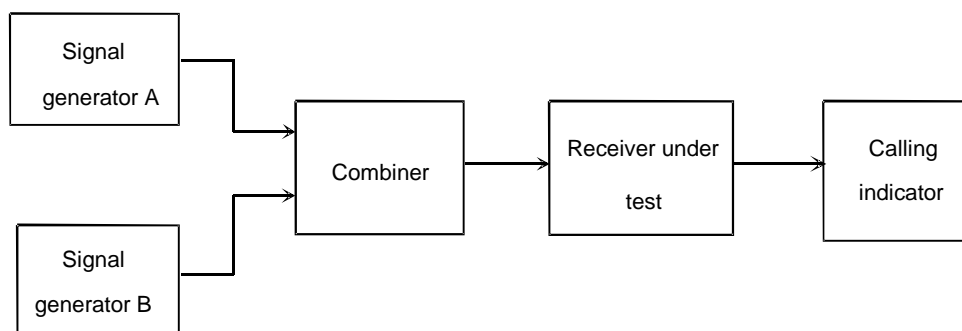

Figure 19: Measurement arrangement

The measurement procedure shall be as follows:

- a) two signal generators A and B shall be connected to the receiver via a combining network:
 - the wanted signal, represented by signal generator A, shall be at the nominal frequency of the receiver and shall have normal test modulation (D-M3), (see clause 7.3);
 - the unwanted signal, provided by signal generator B, shall be unmodulated and shall be at a frequency from 1 MHz to 10 MHz away from the nominal frequency of the receiver;
 - for practical reasons the measurements shall be carried out at frequencies of the unwanted signal at approximately ± 1 MHz, ± 2 MHz, ± 5 MHz and ± 10 MHz, avoiding those frequencies at which spurious responses occur (see clause 9.6);
- b) initially, signal generator B (the unwanted signal) shall be switched off (maintaining the output impedance):
 - the level of the wanted signal from generator A shall be adjusted to the level which is 3 dB above the level of the limit of the maximum usable sensitivity as specified in clause 5.2.2 at the receiver input terminals (i.e. 6 dB above 1 μ V emf under normal test conditions);
- c) signal generator B shall then be switched on and the level of the unwanted signal adjusted until a successful response ratio of less than approximately 10 % is obtained;
- d) the normal test signal D-M3 shall be transmitted repeatedly whilst observing in each case whether or not a successful response is obtained:
 - the level of the unwanted signal shall be reduced by 2 dB for each occasion that a successful response is not obtained;
 - the procedure shall be continued until three consecutive successful responses are observed;
 - the level of the input signal shall then be noted;
- e) the level of the unwanted signal shall be increased by 1 dB and the new value noted:
 - the normal test signal D-M3 shall then be transmitted 20 times. In each case if a response is not obtained the level of the unwanted signal shall be reduced by 1 dB and the new value noted;
 - if a successful response is obtained the level of the unwanted signal shall not be changed until three consecutive successful responses have been obtained;
 - in this case the unwanted signal level shall be increased by 1 dB and the new value noted;
 - no level of the unwanted signal shall be noted unless preceded by a change in level;
 - the average of the values noted in steps d) and e) (which provides the level corresponding to the successful response ratio of 80 %) shall be noted;

- f) for each frequency of the unwanted signal, the blocking or desensitization shall be expressed as the ratio in dB of the average level recorded in step e) to the level of the wanted signal:
 - this ratio shall be recorded;
- g) the measurement shall be repeated for all the frequencies defined above in step a);
- h) the blocking or desensitization of the equipment under test shall be expressed as the lower of the two values recorded in step f).

9.8.3 Limits

The blocking ratio, for any frequency within the specified ranges, shall not be less than 84,0 dB, except at frequencies on which spurious responses are found (see clause 9.6).

9.9 Receiver spurious radiations

9.9.0 Applicability

This measurement need not be carried out if this parameter has already been measured according to the requirements of ETSI EN 300 086 [3].

9.9.1 Definition

Spurious radiations from the receiver are components at any frequency, radiated by the equipment and antenna.

The level of spurious radiations shall be measured by: either

- a) their power level in a specified load (conducted spurious emission); and
- b) their effective radiated power when radiated by the cabinet and structure of the equipment (cabinet radiation);
or
- c) their effective radiated power when radiated by the cabinet and the integral antenna, in the case of handportable equipment fitted with such an antenna and no external RF connector.

9.9.2 Method of measuring the power level

This method applies only to equipment with an external antenna connector.

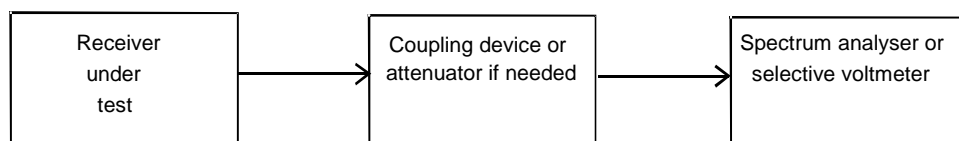

Figure 20: Measurement arrangement

This method applies only to equipment having an external antenna connector.

Spurious radiations shall be measured as the power level of any discrete signal at the input terminals of the receiver. The receiver input terminals are connected to a spectrum analyser or selective voltmeter having an input impedance of 50 Ω and the receiver is switched on.

If the detecting device is not calibrated in terms of power input, the level of any detected components shall be determined by a substitution method using a signal generator.

The measurements shall extend, for equipment operating on frequencies not exceeding 470 MHz, over the frequency range of 9 kHz to 4 GHz, and in addition shall be repeated over the frequency range 4 GHz to 12,75 GHz for equipment operating on frequencies above 470 MHz.

9.9.3 Method of measuring the effective radiated power

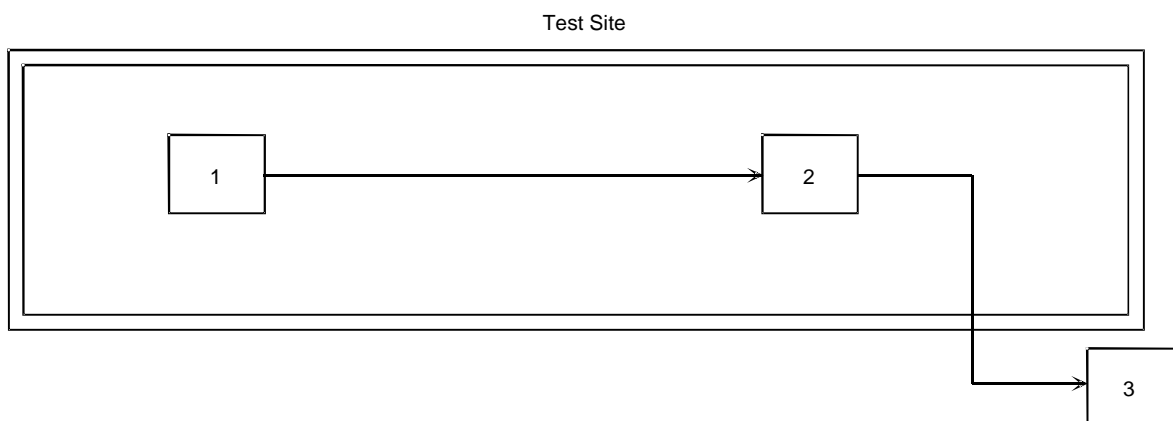

- 1) Receiver under test.
- 2) Test antenna.
- 3) Spectrum analyser or selective voltmeter (test receiver).

Figure 21: Measurement arrangement

The measurement procedure shall be as follows:

- a) on a test site, fulfilling the requirements of clause A.1 of annex A, the sample shall be placed at the specified height on the non-conducting support. The receiver shall be operated from a power source via a radio frequency filter to avoid radiation from the power leads;
- b) the receiver shall be connected:
 - to an artificial antenna (clause 7.5) for equipment having an external antenna connector (clause 9.9.1 b)); or
 - to the integral antenna (clause 9.9.1 c));
- c) radiation of any spurious components shall be detected by the test antenna and receiver, over the frequency range 30 MHz to 4 GHz using the measurement arrangement of figure 21;

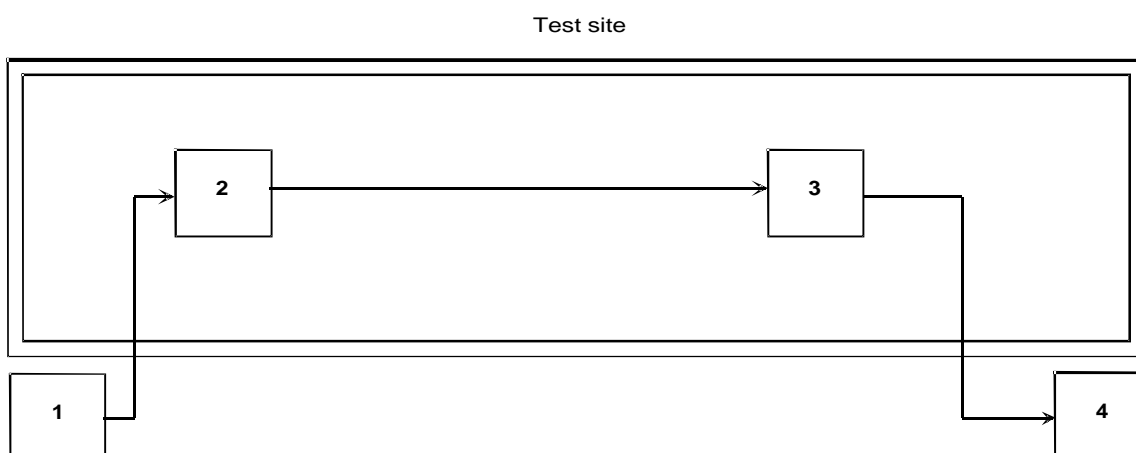

- 1) Signal generator.
- 2) Substitution antenna.
- 3) Test antenna.
- 4) Spectrum analyser or selective voltmeter (test receiver).

Figure 22: Measurement arrangement

- d) at each frequency at which a component is detected, the sample shall be rotated to obtain maximum response and the effective radiated power of that component determined by a substitution measurement, using the measurement arrangement of figure 22;
- e) the measurement shall be repeated with the test antenna in the orthogonal polarization plane.

9.9.4 Limits

The power of any spurious radiation shall not exceed the values given in tables 9 and 10.

Table 9: Conducted components

Frequency range	Limit
9 kHz to 1GHz	2,0 nW (-57 dBm)
1 GHz to 4 GHz, or 1 GHz to 12,75 GHz (clause 9.9.2)	20,0 nW (-47 dBm)

Table 10: Radiated components

Frequency range	Limits
30 MHz to 1 GHz	2,0 nW (-57 dBm)
1 GHz to 4 GHz	20,0 nW (-47 dBm)

In the case of radiated measurements for handportable stations the following conditions apply:

- for equipment having an external antenna socket, an artificial load shall be connected to the socket during the test;
- for equipment having no external antenna socket, the normal integral antenna shall be used.

10 Duplex operation

10.0 Applicability

This measurement need not be carried out if this parameter has already been measured according to the requirements of ETSI EN 300 086 [3].

If the equipment is designed for duplex operation, when tested it shall be fitted with a duplex filter and the following additional measurements shall be carried out to ensure satisfactory duplex operation.

Duplex measurements shall be carried out on a single pair of frequencies only, as specified by the manufacturer/applicant in consultation with the appropriate body.

Duplex equipment having integral antenna may be tested using the internal or temporary antenna connector.

10.1 Receiver desensitization (with simultaneous transmission and reception)

10.1.1 Definition

The desensitization is the degradation of the sensitivity of the receiver resulting from the transfer of power from the transmitter to the receiver due to coupling effects. It is expressed as the difference in dB between the maximum usable sensitivity levels, with and without simultaneous transmissions.

10.1.2 Method of measurement when the equipment operates with a duplex filter

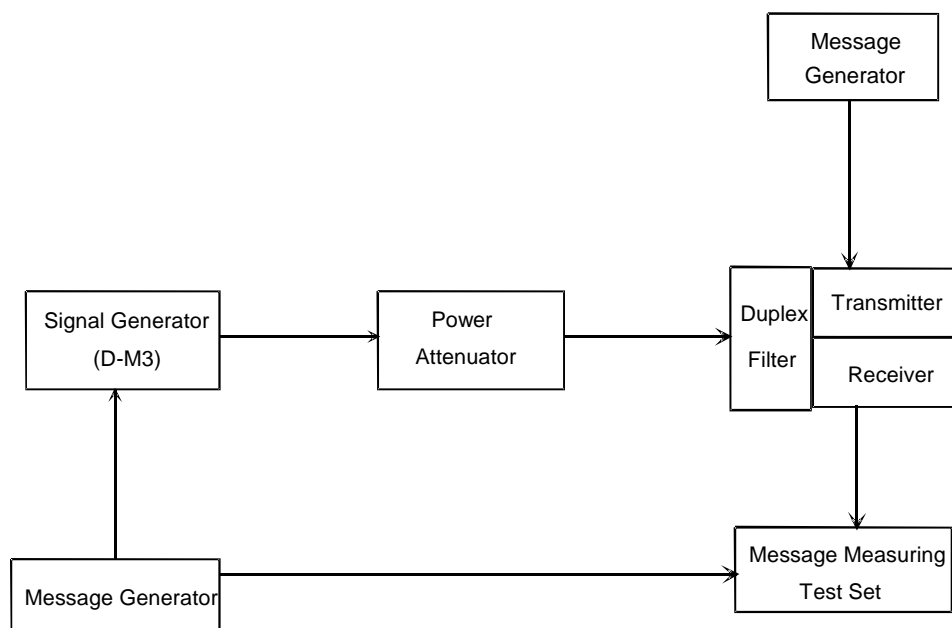

Figure 23: Measurement arrangement

The measurement procedure shall be as follows:

- a) the antenna connector of the equipment shall be connected to a power attenuator, giving sufficient protection to the devices connected to the power attenuator output:
 - a signal generator, having test modulation D-M3 (see clause 7.3) shall be connected to the power attenuator so that it does not affect the impedance matching and does not generate intermodulation products which impair the results of the measurement;
- b) the transmitter shall be brought into operation with an output power as defined in clause 8.2 and shall be modulated by test signal D-M4:
 - the receiver sensitivity shall be measured in accordance with clause 9.2;
- c) the output level of the signal generator shall be noted as C in dB relative to an emf of $1\mu\text{V}$;
- d) the transmitter shall be switched off and the receiver sensitivity measured again;
- e) the output level of the signal generator shall be recorded as D in dB relative to an emf of $1\mu\text{V}$;
- f) the desensitization is the difference between the values of C and D in dB.

10.1.3 Method of measurement when the equipment operates with separate Tx and Rx antennas

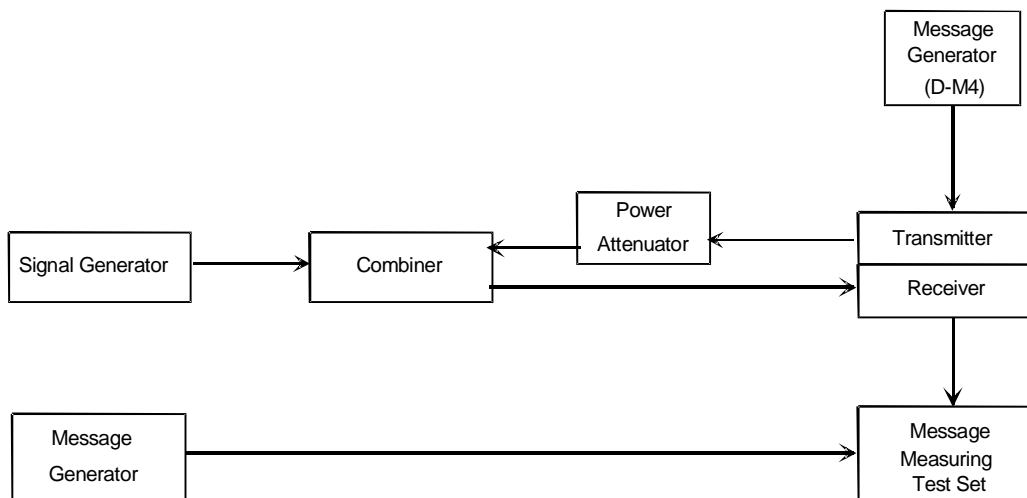

Figure 24: Measurement arrangement

The measurement procedure shall be as follows:

- a) the transmitter shall be connected to a power attenuator (see clause 7.5), the output of which shall be connected to the receiver through a coupling device:
 - the total attenuation of the power attenuator and combiner shall be 30 dB which is intended to simulate a corresponding antenna isolation;
 - if an external filter at the transmitter output or an external filter at the receiver input or both are part of the normal operation arrangement, this or these filters shall be included in the measurement arrangement accordingly;
 - a signal generator having normal test modulation (see clause 7.3) shall be connected to the combiner so that it does not affect the impedance matching, and does not generate intermodulation products which could impair the results of the measurement;
- b) the transmitter shall be brought into operation with an output power as defined in clause 8.2, and shall be modulated by test signal D-M4, using a message different from the message used in step a):
 - the receiver sensitivity shall be measured in accordance with clause 9.2;
- c) the output level of the signal generator shall be noted as C in dB relative to an emf of 1µV;
- d) the transmitter shall be switched off and the receiver sensitivity measured again;
- e) the output level of the signal generator shall be recorded as D in dB relative to an emf of 1µV;
- f) the desensitization is the difference between the values of C and D in dB.

10.1.4 Limits

The desensitization shall not exceed 3,0 dB, and the limit of maximum usable sensitivity under normal test conditions, clause 5.2.2, shall be met.

10.2 Receiver spurious response rejection (with simultaneous transmission and reception)

10.2.1 Definition

The spurious response rejection, under duplex operation, is a measure of the capability of the receiver to achieve a specific successful response ratio when receiving a wanted modulated signal in the presence of:

- an unwanted unmodulated signal, which is added at any other frequency at which a response may be obtained; and
- the unmodulated signal of the transmitter operating at duplex frequency distance at the rated output power and attenuated by the duplex filter or the distance between the antennas.

10.2.2 Method of measurement

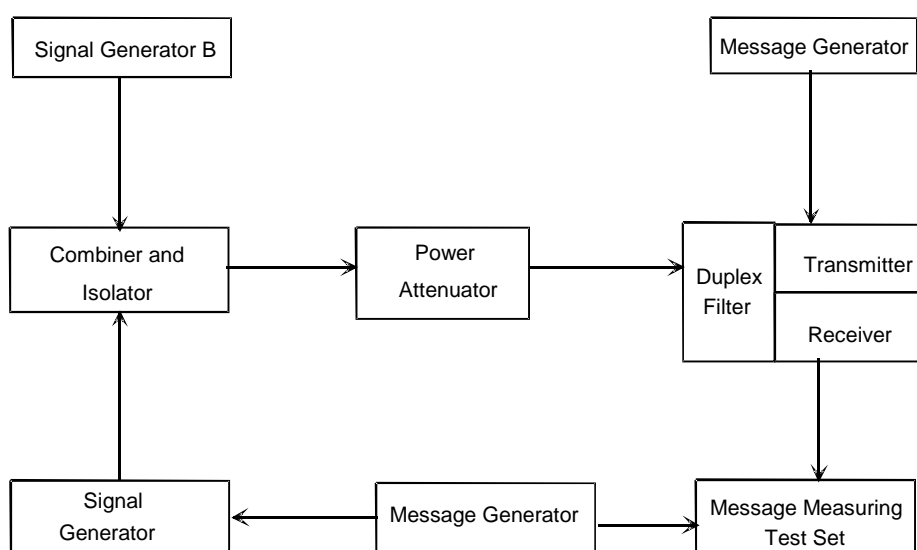

Figure 25: Measurement arrangement

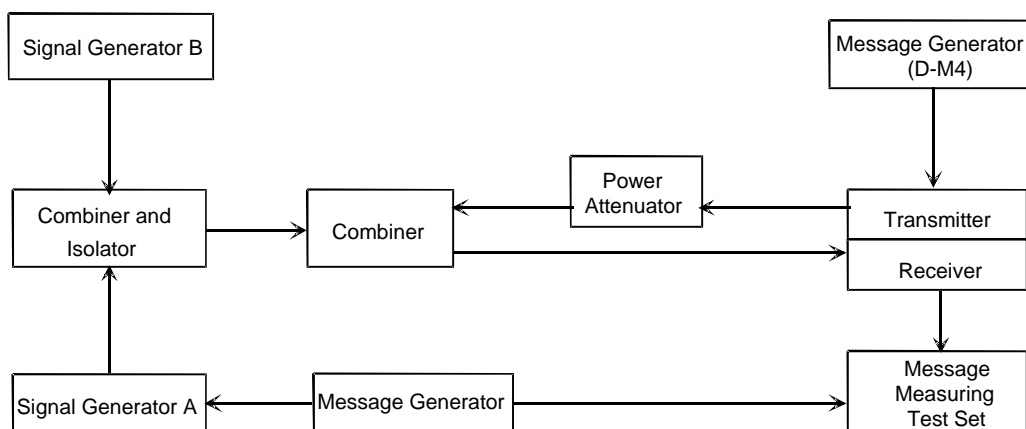

Figure 26: Measurement arrangement

The measurement procedure shall be as follows.

The receiver spurious response rejection under duplex operation shall be measured as specified in clause 9.6 with the equipment arrangement as shown in figures 25 or 26 and described in clauses 10.1.2 or 10.1.3, except that the transmitter shall be unmodulated. If an unmodulated carrier cannot be obtained, the transmitter shall be modulated by the test signal D-M4 (see clause 7.3). The transmitter shall be operated at the rated output power as defined in clause 8.2.

The measurement shall be performed at frequencies (f_m) derived from the expressions:

- $(p)f_t + (q)f_m = f_r$ and $f_m = (n)f_t \pm f_{if1}$;
- where f_t is the transmitter frequency;
- where f_r is the receiver frequency; and
- f_{if1} is the first IF of the receiver;
- $n = \geq 2$.

Particular attention shall be made to the following values:

- $(p) = -1, (q) = 2$ and $(p) = 2, (q) = -1$.

It shall be noted that the method of measurement described may cause errors at certain frequencies due to the effect of signal generator intermodulation. To overcome such errors, a band stop filter at the transmitting frequency may be inserted between the output of the signal generator combining network and the equipment under test.

10.2.3 Limits

At any frequency separated from the nominal frequency of the receiver by more than two channels, the spurious response rejection ratio shall not be less than 67,0 dB.

11 Testing for compliance with technical requirements

11.1 Test conditions, power supply and ambient temperatures

Tests defined in the present document shall be carried out at representative points within the boundary limits of the declared operational environmental profile which, as a minimum, shall be that specified in the test conditions contained in the present document.

As technical performance varies subject to environmental conditions, tests shall be carried out under a sufficient variety of environmental conditions as specified in the present document to give confidence of compliance for the affected technical requirements.

11.2 Interpretation of the measurement results

The interpretation of the results recorded in a test report for the measurements described in the present document shall be as follows:

- the measured value related to the corresponding limit will be used to decide whether equipment meets the requirements of the present document;
- the value of the measurement uncertainty for the measurement of each parameter shall be included in the test report;
- the recorded value of the measurement uncertainty shall be, for each measurement, equal to or lower than the figures in table 1.

For the test methods, according to the present document, the measurement uncertainty figures shall be calculated and shall correspond to an expansion factor (coverage factor) $k = 1,96$ or $k = 2$ (which provide confidence levels of respectively 95 % and 95,45 % in the case where the distributions characterizing the actual measurement uncertainties are normal (Gaussian)). Principles for the calculation of measurement uncertainty are contained in ETSI TR 100 028 [2], parts 1 and 2, in particular in annex D of the ETSI TR 100 028-2 [5].

Table 11 is based on such expansion factors.

Table 11: Absolute measurement uncertainties: maximum values

Parameter	Uncertainty
Radio Frequency	$\pm 1 \times 10^{-7}$
RF Power (up to 160 W)	$\pm 0,75$ dB
Radiated RF power	± 6 dB
Adjacent channel power	± 5 dB
Conducted spurious emission of transmitter valid up to 12,75 GHz	± 4 dB
Conducted spurious emission of receiver, valid up to 12,75 GHz	± 3 dB
Two-signal measurement, valid up to 4 GHz	± 4 dB
Three-signal measurement	± 3 dB
Radiated emission of the transmitter, valid up to 4 GHz	± 6 dB
Radiated emission of receiver, valid up to 4 GHz	± 6 dB
Transmitter attack time	± 20 %
Transmitter release time	± 20 %
Transmitter transient frequency (frequency difference)	± 250 Hz
Transmitter intermodulation	± 3 dB
Receiver desensitization (duplex operation)	$\pm 0,5$ dB
Valid up to 1 GHz for the RF parameters unless otherwise stated.	

Annex A (normative): Radiated measurement

A.1 Test sites and general arrangements for measurements involving the use of radiated fields

A.1.0 General

This annex introduces three most commonly available test sites, an Anechoic Chamber, an Anechoic Chamber with a ground plane and an Open Area Test Site (OATS), which may be used for radiated tests. These test sites are generally referred to as free field test sites. Both absolute and relative measurements can be performed in these sites. Where absolute measurements are to be carried out, the chamber should be verified. A detailed verification procedure is described in ETSI TR 102 273 [i.3] relevant parts 2, 3 and 4.

NOTE: To ensure reproducibility and traceability of radiated measurements only these test sites should be used in measurements in accordance with the present document.

A.1.1 Anechoic chamber

An anechoic chamber is an enclosure, usually shielded, whose internal walls, floor and ceiling are covered with radio absorbing material, normally of the pyramidal urethane foam type. The chamber usually contains an antenna support at one end and a turntable at the other. A typical anechoic chamber is shown in figure A.1.

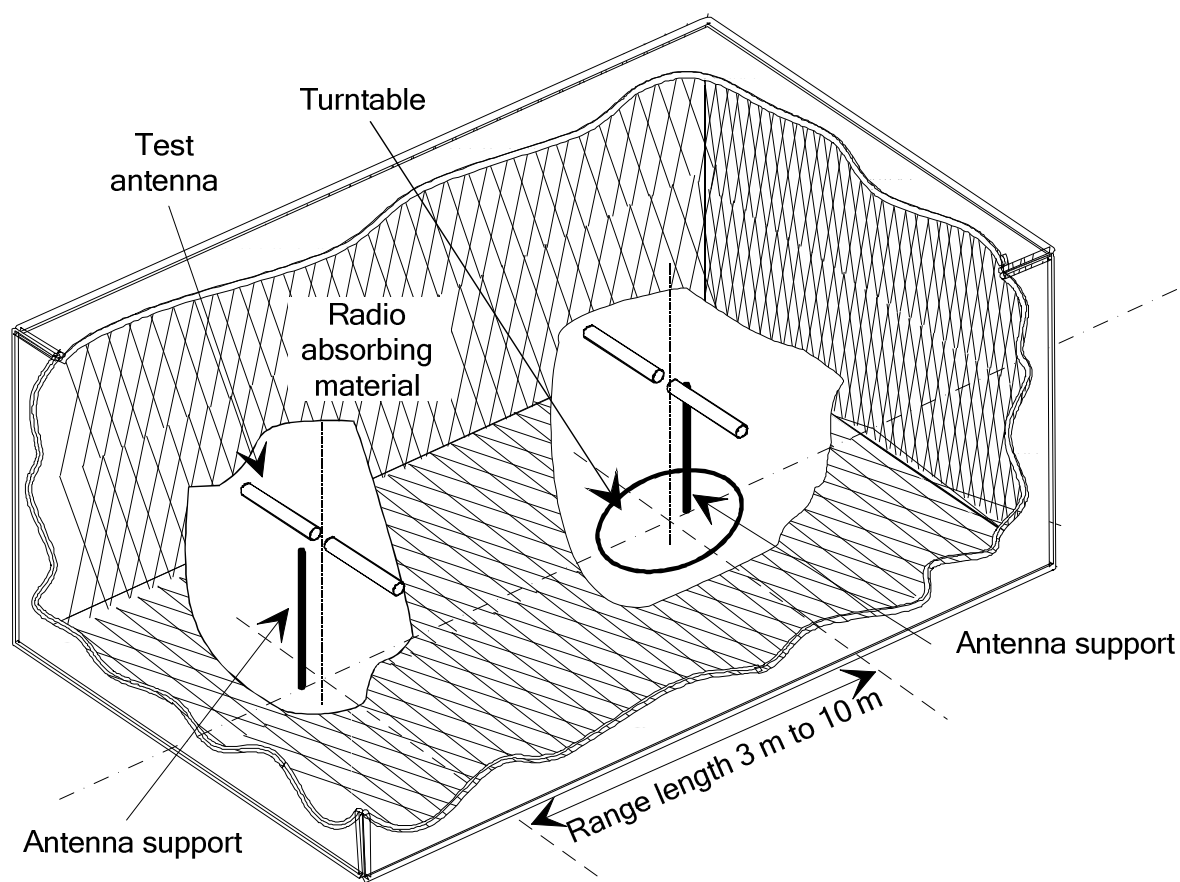

Figure A.1: A typical anechoic chamber

The chamber shielding and radio absorbing material work together to provide a controlled environment for testing purposes. This type of test chamber attempts to simulate free space conditions.

The shielding provides a test space, with reduced levels of interference from ambient signals and other outside effects, whilst the radio absorbing material minimizes unwanted reflections from the walls and ceiling which can influence the measurements. In practice it is relatively easy for shielding to provide high levels (80 dB to 140 dB) of ambient interference rejection, normally making ambient interference negligible.

A turntable is capable of rotation through 360° in the horizontal plane and it is used to support the test sample (EUT) at a suitable height (e.g. 1 m) above the ground plane. The chamber shall be large enough to allow the measuring distance of at least 3 m or $2(d_1 + d_2)^2/\lambda$ (m), whichever is greater (see to clause A.2.5). The distance used in actual measurements shall be recorded with the test results.

The anechoic chamber generally has several advantages over other test facilities. There is minimal ambient interference, minimal floor, ceiling and wall reflections and it is independent of the weather. It does however have some disadvantages which include limited measuring distance and limited lower frequency usage due to the size of the pyramidal absorbers. To improve low frequency performance, a combination structure of ferrite tiles and urethane foam absorbers is commonly used.

All types of emission, sensitivity and immunity testing can be carried out within an Anechoic Chamber without limitation.

A.1.2 Anechoic chamber with a conductive ground plane

An anechoic chamber with a conductive ground plane is an enclosure, usually shielded, whose internal walls and ceiling are covered with radio absorbing material, normally of the pyramidal urethane foam type. The floor, which is metallic, is not covered and forms the ground plane. The chamber usually contains an antenna mast at one end and a turntable at the other. A typical anechoic chamber with a conductive ground plane is shown in figure A.2.

This type of test chamber attempts to simulate an ideal Open Area Test Site whose primary characteristic is a perfectly conducting ground plane of infinite extent.

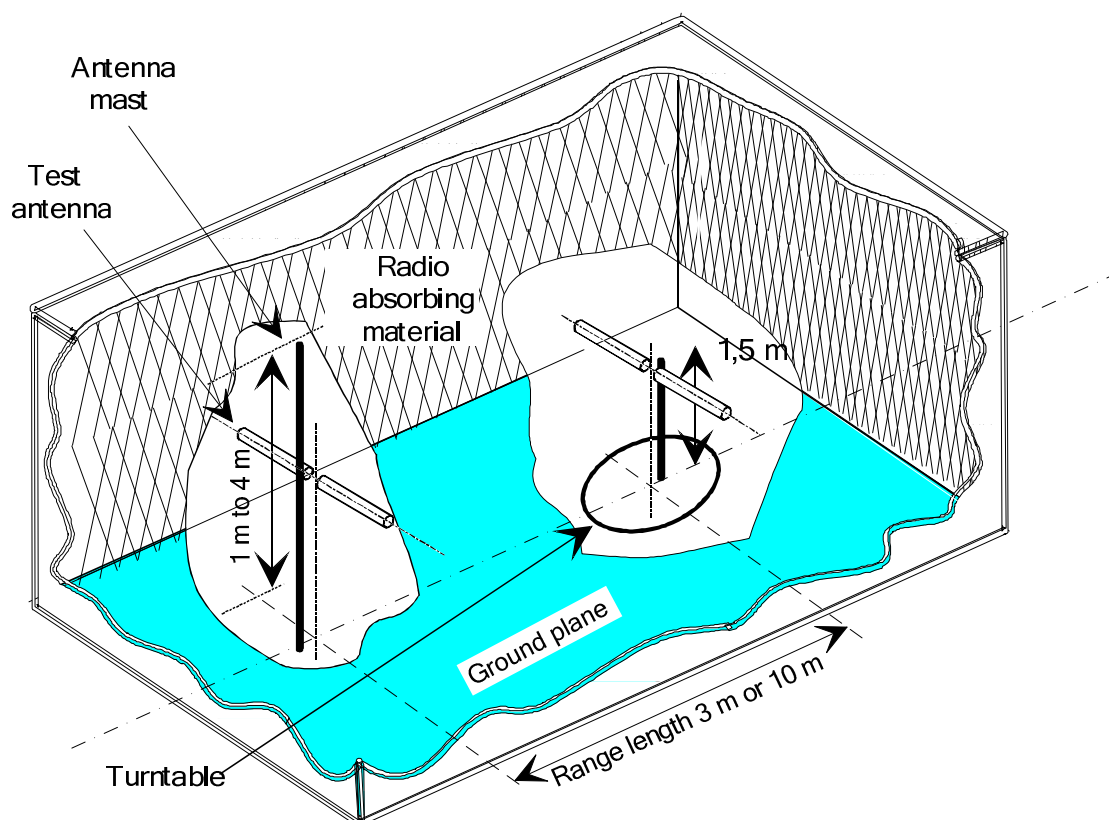

Figure A.2: A typical anechoic chamber with a conductive ground plane

In this facility the ground plane creates the wanted reflection path, such that the signal received by the receiving antenna is the sum of the signals from both the direct and reflected transmission paths. This creates a unique received signal level for each height of the transmitting antenna (or EUT) and the receiving antenna above the ground plane.

The antenna mast provides a variable height facility (from 1 to 4 metres) so that the position of the test antenna can be optimized for maximum coupled signal between antennas or between a EUT and the test antenna.

A turntable is capable of rotation through 360° in the horizontal plane and it is used to support the test sample (EUT) at a specified height, usually 1,5 metres above the ground plane. The chamber shall be large enough to allow the measuring distance of at least 3 m or $2(d_1 + d_2)/\lambda$ (m), whichever is greater (see clause A.2.5). The distance used in actual measurements shall be recorded with the test results.

Emission testing involves firstly "peaking" the field strength from the EUT by raising and lowering the receiving antenna on the mast (to obtain the maximum constructive interference of the direct and reflected signals from the EUT) and then rotating the turntable for a "peak" in the azimuth plane. At this height of the test antenna on the mast, the amplitude of the received signal is noted. Secondly the EUT is replaced by a substitution antenna (positioned at the EUT's phase or volume centre) which is connected to a signal generator. The signal is again "peaked" and the signal generator output adjusted until the level, noted in stage one, is again measured on the receiving device.

Receiver sensitivity tests over a ground plane also involve "peaking" the field strength by raising and lowering the test antenna on the mast to obtain the maximum constructive interference of the direct and reflected signals, this time using a measuring antenna which has been positioned where the phase or volume centre of the EUT will be during testing. A transform factor is derived. The test antenna remains at the same height for stage two, during which the measuring antenna is replaced by the EUT. The amplitude of the transmitted signal is reduced to determine the field strength level at which a specified response is obtained from the EUT.

A.1.3 Open Area Test Site (OATS)

An Open Area Test Site comprises a turntable at one end and an antenna mast of variable height at the other end above a ground plane which, in the ideal case, is perfectly conducting and of infinite extent. In practice, while good conductivity can be achieved, the ground plane size has to be limited. A typical Open Area Test Site is shown in figure A.3.

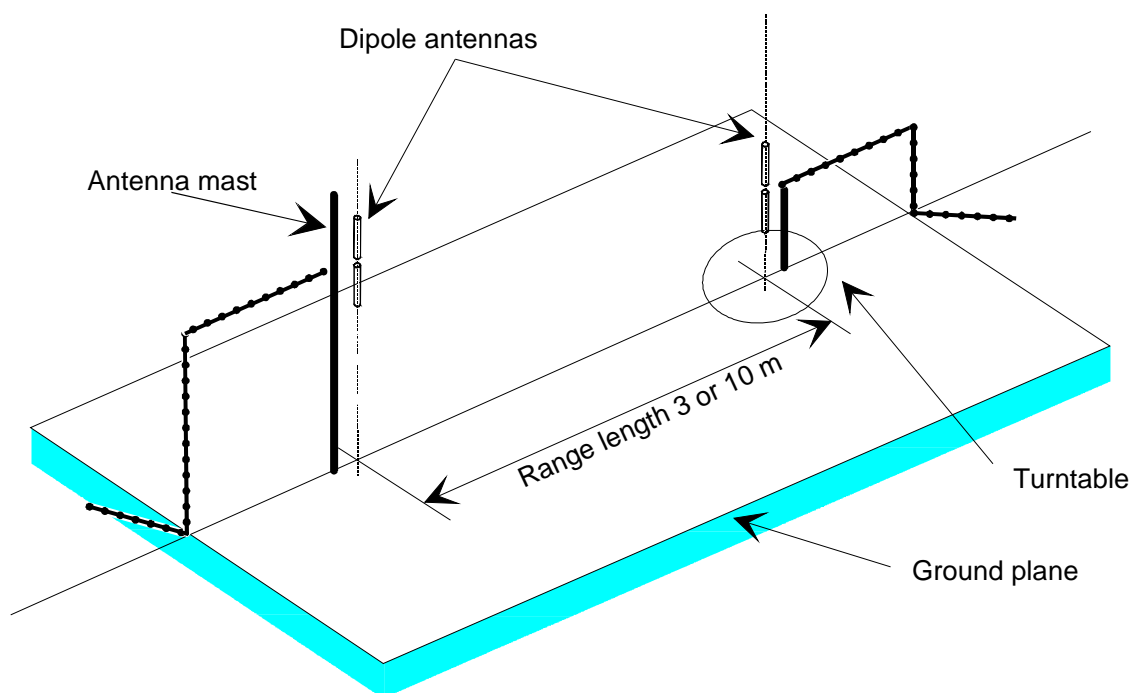

Figure A.3: A typical Open Area Test Site

The ground plane creates a wanted reflection path, such that the signal received by the receiving antenna is the sum of the signals received from the direct and reflected transmission paths. The phasing of these two signals creates a unique received level for each height of the transmitting antenna (or EUT) and the receiving antenna above the ground plane.

Site qualification concerning antenna positions, turntable, measurement distance and other arrangements are same as for anechoic chamber with a ground plane. In radiated measurements an OATS is also used by the same way as anechoic chamber with a ground plane.

Typical measuring arrangement common for ground plane test sites is presented in the figure A.4.

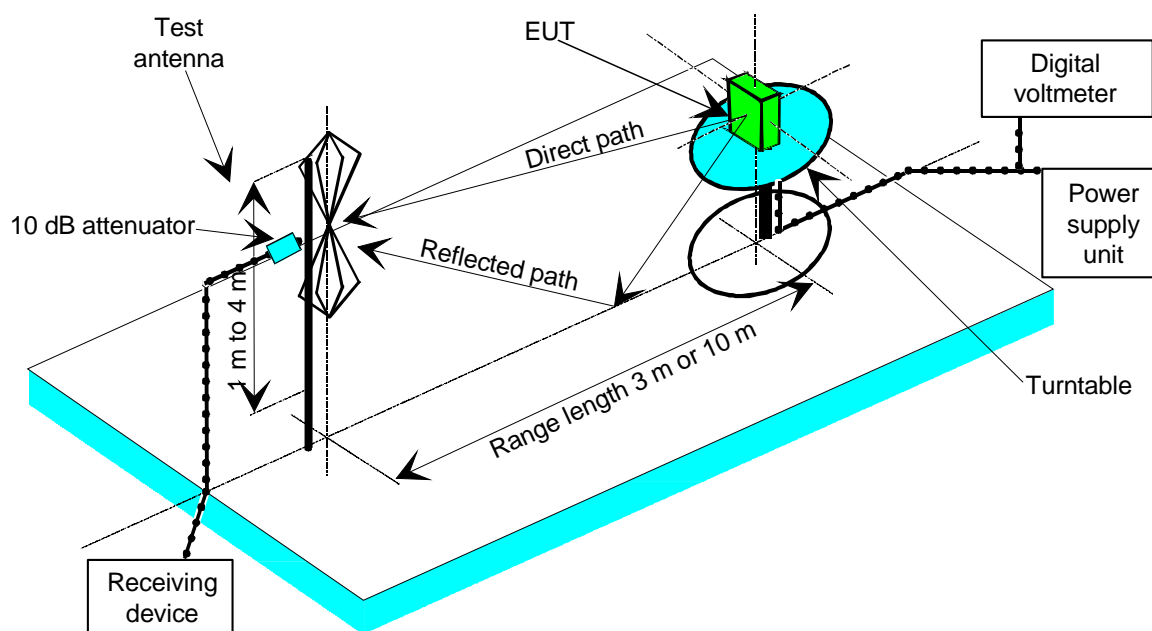

Figure A.4: Measuring arrangement on ground plane test site (OATS set-up for spurious emission testing)

A.1.4 Test antenna

A test antenna is always used in radiated test methods. In emission tests (i.e. frequency error, effective radiated power, spurious emissions and adjacent channel power) the test antenna is used to detect the field from the EUT in one stage of the measurement and from the substitution antenna in the other stage. When the test site is used for the measurement of receiver characteristics (i.e. sensitivity and various immunity parameters) the antenna is used as the transmitting device.

The test antenna should be mounted on a support capable of allowing the antenna to be used in either horizontal or vertical polarization which, on ground plane sites (i.e. Anechoic Chambers with ground planes and Open Area Test Sites), should additionally allow the height of its centre above the ground to be varied over the specified range (usually 1 to 4 metres).

In the frequency band 30 MHz to 1 000 MHz, dipole antennas (constructed in accordance with ANSI C63.5 [i.4]) are generally recommended. For frequencies of 80 MHz and above, the dipoles should have their arm lengths set for resonance at the frequency of test. Below 80 MHz, shortened arm lengths are recommended. For spurious emission testing, however, a combination of biconical antennas (commonly termed "bicones") and log periodic dipole array antennas (commonly termed "log periodics") could be used to cover the entire 30 MHz to 1 000 MHz band. Above 1 000 MHz, waveguide horns are recommended although, again, log periodics could be used.

NOTE: The gain of a horn antenna is generally expressed relative to an isotropic radiator.

A.1.5 Substitution antenna

The substitution antenna is used to replace the EUT for tests in which a transmitting parameter (i.e. frequency error, effective radiated power, spurious emissions and adjacent channel power) is being measured. For measurements in the frequency band 30 MHz to 1 000 MHz, the substitution antenna should be a dipole antenna (constructed in accordance with ANSI C63.5 [i.4]). For frequencies of 80 MHz and above, the dipoles should have their arm lengths set for resonance at the frequency of test. Below 80 MHz, shortened arm lengths are recommended. For measurements above 1 000 MHz, a waveguide horn is recommended. The centre of this antenna should coincide with either the phase centre or volume centre.

A.1.6 Measuring antenna

The measuring antenna is used in tests on a EUT in which a receiving parameter (i.e. sensitivity and various immunity tests) is being measured. Its purpose is to enable a measurement of the electric field strength in the vicinity of the EUT. For measurements in the frequency band 30 MHz to 1 000 MHz, the measuring antenna should be a dipole antenna (constructed in accordance with ANSI C63.5 [i.4]). For frequencies of 80 MHz and above, the dipoles should have their arm lengths set for resonance at the frequency of test. Below 80 MHz, shortened arm lengths are recommended. The centre of this antenna should coincide with either the phase centre or volume centre (as specified in the test method) of the EUT.

A.2 Guidance on the use of radiation test sites

A.2.0 General

This clause details procedures, test equipment arrangements and verification that should be carried out before any of the radiated test are undertaken. These schemes are common to all types of test sites described in annex A.

A.2.1 Verification of the test site

No test should be carried out on a test site which does not possess a valid certificate of verification. The verification procedures for the different types of test sites described in annex A (i.e. Anechoic Chamber, Anechoic Chamber with a ground plane and Open Area Test Site) are given in ETSI TR 102 273 [i.3] parts 2, 3 and 4, respectively.

A.2.2 Preparation of the EUT

The manufacturer should supply information about the EUT covering the operating frequency, polarization, supply voltage(s) and the reference face. Additional information, specific to the type of EUT should include, where relevant, carrier power, channel separation, whether different operating modes are available (e.g. high and low power modes) and if operation is continuous or is subject to a maximum test duty cycle (e.g. 1 minute on, 4 minutes off).

Where necessary, a mounting bracket of minimal size should be available for mounting the EUT on the turntable. This bracket should be made from low conductivity, low relative dielectric constant (i.e. less than 1,5) material(s) such as expanded polystyrene, balsawood, etc.

A.2.3 Power supplies to the EUT

All tests should be performed using power supplies wherever possible, including tests on EUT designed for battery-only use. In all cases, power leads should be connected to the EUT's supply terminals (and monitored with a digital voltmeter) but the battery should remain present, electrically isolated from the rest of the equipment, possibly by putting tape over its contacts.

The presence of these power cables can, however, affect the measured performance of the EUT. For this reason, they should be made to be "transparent" as far as the testing is concerned. This can be achieved by routing them away from the EUT and down to the either the screen, ground plane or facility wall (as appropriate) by the shortest possible paths. Precautions should be taken to minimize pick-up on these leads (e.g. the leads could be twisted together, loaded with ferrite beads at 0,15 metre spacing or otherwise loaded).

A.2.4 Volume control setting for analogue speech tests

Unless otherwise stated, in all receiver measurements for analogue speech the receiver volume control where possible, should be adjusted to give at least 50 % of the rated audio output power. In the case of stepped volume controls, the volume control should be set to the first step that provides an output power of at least 50 % of the rated audio output power. This control should not be readjusted between normal and extreme test conditions in tests.

A.2.5 Range length

The range length for all these types of test facility should be adequate to allow for testing in the far-field of the EUT i.e. it should be equal to or exceed:

$$\frac{2(d_1 + d_2)^2}{\lambda}$$

Where:

- d_1 is the largest dimension of the EUT/dipole after substitution (m);
- d_2 is the largest dimension of the test antenna (m);
- λ is the test frequency wavelength (m).

It should be noted that in the substitution part of this measurement, where both test and substitution antennas are half wavelength dipoles, this minimum range length for far-field testing would be:

$$2\lambda$$

It should be noted in test reports when either of these conditions is not met so that the additional measurement uncertainty can be incorporated into the results.

NOTE 1: For the fully anechoic chamber, no part of the volume of the EUT should, at any angle of rotation of the turntable, fall outside the "quiet zone" of the chamber at the nominal frequency of the test.

NOTE 2: The "quiet zone" is a volume within the Anechoic Chamber (without a ground plane) in which a specified performance has either been proven by test, or is guaranteed by the designer/manufacturer. The specified performance is usually the reflectivity of the absorbing panels or a directly related parameter (e.g. signal uniformity in amplitude and phase). It should be noted however that the defining levels of the quiet zone tend to vary.

NOTE 3: For the anechoic chamber with a ground plane, a full height scanning capability, i.e. 1 to 4 metres, should be available for which no part of the test antenna should come within 1 metre of the absorbing panels. For both types of Anechoic Chamber, the reflectivity of the absorbing panels should not be worse than -5 dB.

NOTE 4: For both the anechoic chamber with a ground plane and the Open Area Test Site, no part of any antenna should come within 0,25 metre of the ground plane at any time throughout the tests. Where any of these conditions cannot be met, measurements should not be carried out.

A.2.6 Site preparation

The cables for both ends of the test site should be routed horizontally away from the testing area for a minimum of 2 metres (unless, in the case both types of anechoic chamber, a back wall is reached) and then allowed to drop vertically and out through either the ground plane or screen (as appropriate) to the test equipment. Precautions should be taken to minimize pick up on these leads (e.g. dressing with ferrite beads, or other loading). The cables, their routing and dressing should be identical to the verification set-up.

NOTE: For ground reflection test sites (i.e. anechoic chambers with ground planes and Open Area Test Sites) which incorporate a cable drum with the antenna mast, the 2 metres requirement may be impossible to comply with.

Calibration data for all items of test equipment should be available and valid. For test, substitution and measuring antennas, the data should include gain relative to an isotropic radiator (or antenna factor) for the frequency of test. Also, the VSWR of the substitution and measuring antennas should be known.

The calibration data on all cables and attenuators should include insertion loss and VSWR throughout the entire frequency range of the tests. All VSWR and insertion loss figures should be recorded in the log book results sheet for the specific test.

Where correction factors/tables are required, these should be immediately available.

For all items of test equipment, the maximum errors they exhibit should be known along with the distribution of the error e.g.:

- cable loss: $\pm 0,5$ dB with a rectangular distribution;
- measuring receiver: 1,0 dB (standard deviation) signal level accuracy with a Gaussian error distribution.

At the start of measurements, system checks should be made on the items of test equipment used on the test site.

A.3 Coupling of signals

A.3.1 General

The presence of leads in the radiated field may cause a disturbance of that field and lead to additional measurement uncertainty. These disturbances can be minimized by using suitable coupling methods, offering signal isolation and minimum field disturbance (e.g. optical and acoustic coupling).

A.3.2 Data signals

Isolation can be provided by the use of optical, ultrasonic or infra-red means. Field disturbance can be minimized by using a suitable fibre optic connection. ultrasonic or infra-red radiated connections require suitable measures for the minimization of ambient noise.

A.3.3 Speech and analogue signals

A.3.3.0 General

Where an audio output socket is not available an acoustic coupler should be used.

When using the acoustic coupler, care should be exercised that possible ambient noise does not influence the test result.

A.3.3.1 Acoustic coupler description

The acoustic coupler comprises a plastic funnel, an acoustic pipe and a microphone with a suitable amplifier. The materials used to fabricate the funnel and pipe should be of low conductivity and of low relative dielectric constant (i.e. less than 1,5).

- The acoustic pipe should be long enough to reach from the EUT to the microphone which should be located in a position that will not disturb the RF field. The acoustic pipe should have an inner diameter of about 6 mm and a wall thickness of about 1,5 mm and should be sufficiently flexible so as not to hinder the rotation of the turntable.
- The plastic funnel should have a diameter appropriate to the size of the loudspeaker in the EUT, with soft foam rubber glued to its edge, it should be fitted to one end of the acoustic pipe and the microphone should be fitted to the other end. It is very important to fix the centre of the funnel in a reproducible position relative to the EUT, since the position of the centre has a strong influence on the frequency response that will be measured. This can be achieved by placing the EUT in a close fitting acoustic mounting jig, supplied by the manufacturer, of which the funnel is an integral part.
- The microphone should have a response characteristic flat within 1 dB over a frequency range of 50 Hz to 20 kHz, a linear dynamic range of at least 50 dB. The sensitivity of the microphone and the receiver audio output level should be suitable to measure a signal to noise ratio of at least 40 dB at the nominal audio output level of the EUT. Its size should be sufficiently small to couple to the acoustic pipe.
- The frequency correcting network should correct the frequency response of the acoustic coupler so that the acoustic SINAD measurement is valid (see IEC 60489-3 [4], appendix F).

A.3.3.2 Calibration

The aim of the calibration of the acoustic coupler is to determine the acoustic SINAD ratio which is equivalent to the SINAD ratio at the receiver output.

A.4 Test fixture

A.4.1 Description

The test fixture is only needed for the assessment of integral antenna equipment.

The test fixture is a radio frequency coupling device associated with an integral antenna equipment for coupling the integral antenna to a 50 Ω radio frequency terminal at the working frequencies of the equipment under test. This allows certain measurements to be performed using the conducted measurement methods. Only relative measurements may be performed and only those at or near frequencies for which the test fixture has been calibrated.

In addition, the test fixture may provide:

- a) a connection to an external power supply;
- b) in the case of assessment of speech equipment, an audio interface either by direct connection or by an acoustic coupler.

In the case of non-speech equipment, the test fixture can also provide the suitable coupling means e.g. for the data output.

The test fixture shall normally be provided by the manufacturer.

The performance characteristics of the test fixture shall conform to the following basic parameters:

- a) the coupling loss shall not be greater than 30 dB;
- b) a coupling loss variation over the frequency range used in the measurement which does not exceed 2 dB;
- c) circuitry associated with the RF coupling shall contain no active or non-linear devices;
- d) the VSWR at the 50 Ω socket shall not be more than 1,5 over the frequency range of the measurements;
- e) the coupling loss shall be independent of the position of the test fixture and be unaffected by the proximity of surrounding objects or people. The coupling loss shall be reproducible when the equipment under test is removed and replaced;
- f) the coupling loss shall remain substantially constant when the environmental conditions are varied.

The characteristics and calibration shall be recorded.

A.4.2 Calibration

The calibration of the test fixture establishes a relationship between the output of the signal generator and the field strength applied to the equipment placed in the test fixture.

The calibration is valid only at a given frequency and for a given polarization of the reference field.

The actual set-up used depends on the type of the equipment (e.g. data, speech, etc.).

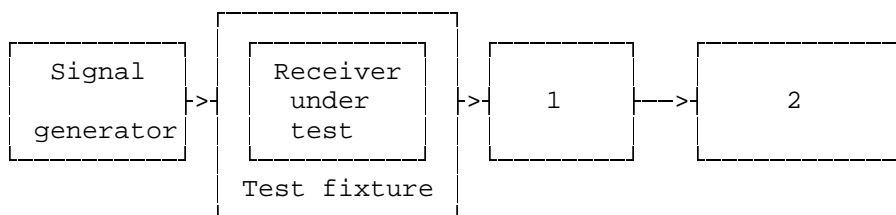

- 1) Coupling device, e.g. AF load/acoustic coupler (in the case of speech equipment).
- 2) Device for assessing the performance, e.g. distortion factor/audio level meter, BER measuring device, etc.

Figure A.5: Measuring arrangement for calibration

Method of calibration:

- a) Measure the sensitivity expressed as a field strength, as specified in the present document and note the value of this field strength in dB μ V/m and the polarization used.
- b) Place the receiver in the test fixture which is connected to the signal generator. The level of the signal generator producing:
 - a SINAD of 20 dB;
 - a bit error ratio of 0,01; or
 - a message acceptance ratio of 80 %, as appropriate,
 shall be noted.

The calibration of the test fixture is the relationship between the field strength in dB μ V/m and the signal generator level in dB μ V emf. This relationship is expected to be linear.

A.4.3 Mode of use

The test fixture may be used to facilitate some of the measurements in the case of equipment having an integral antenna.

It is used in particularly for the measurement of the radiated carrier power and usable sensitivity expressed as a field strength under the extreme conditions.

For the transmitter measurements calibration is not required as relative measuring methods are used.

For the receiver measurements calibration is necessary as absolute measurements are used.

To apply the specified wanted signal level expressed in field strength, convert it into the signal generator level (emf) using the calibration of the test fixture. Apply this value to the signal generator.

Annex B (normative): Specification for some particular measurement arrangements

B.1 Power measuring receiver specification

B.1.0 General

The power measuring receiver is used for the measurement of the transmitter adjacent channel power. It consists of a mixer and oscillator, an IF filter, an amplifier, a variable attenuator and a level indicator as shown below (figure B.1).

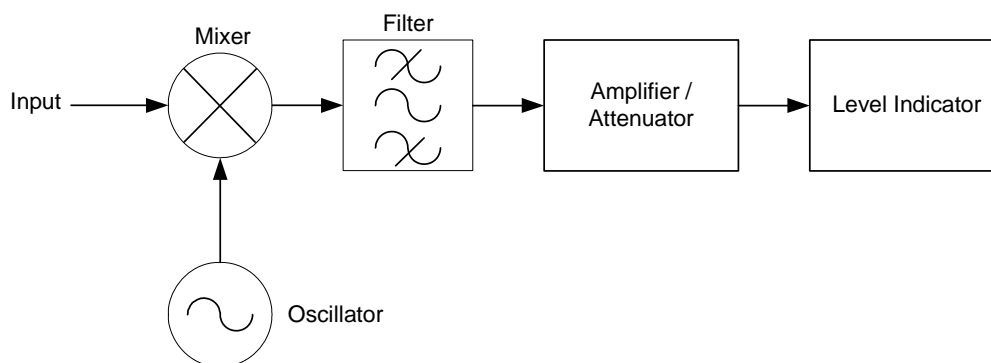

Figure B.1: Power measuring receiver

Instead of the Variable attenuator with the rms value indicator it is also possible to use a rms voltmeter calibrated in dB. The technical characteristics of the power measuring receiver are given in clauses B.1.1 to B.1.5.

B.1.1 IF filter

The IF filter shall be within the limits of the selectivity characteristic of figure B.2.

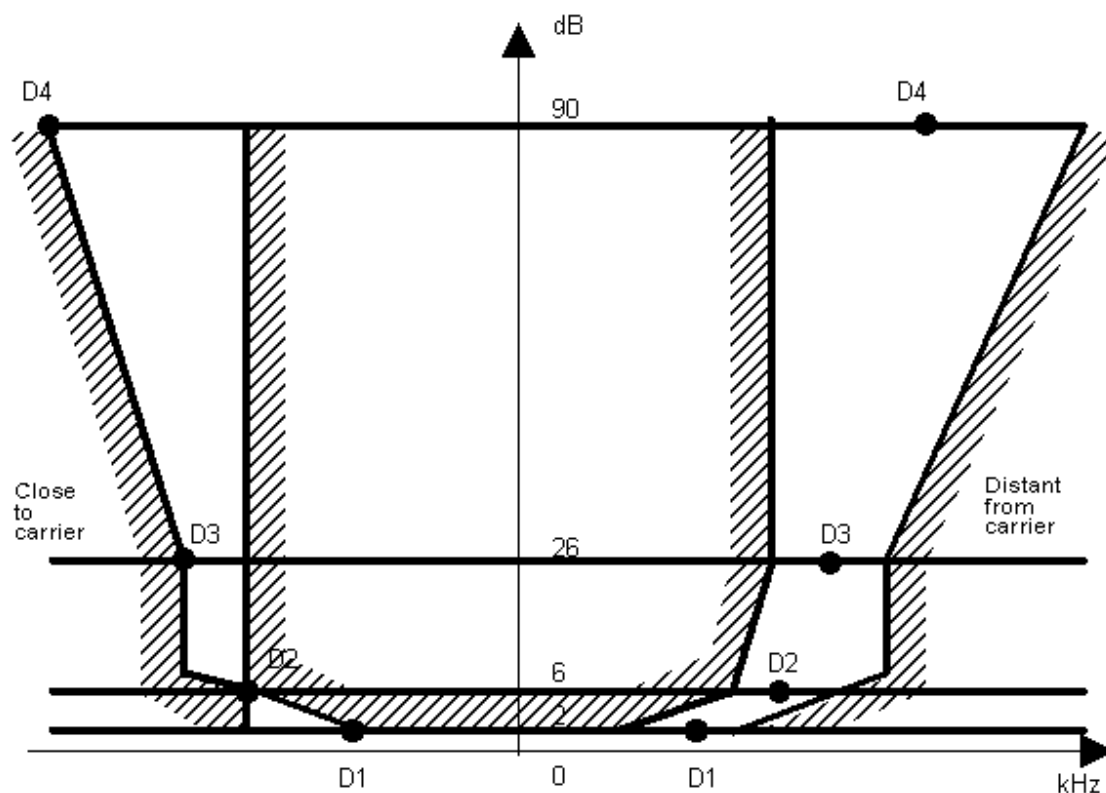

Figure B.2: IF filter

Depending on the channel separation, the selectivity characteristic shall keep the frequency separations from the nominal centre frequency of the adjacent channel as stated in table B.1.

Table B.1: Selectivity characteristic

Channel separation (kHz)	Frequency separation of filter curve from nominal centre frequency of adjacent channel (kHz)			
	D1	D2	D3	D4
12,5	3	4,25	5,5	9,5
20	4	7,0	8,25	12,25
25	5	8,0	9,25	13,25

Depending on the channel separation, the attenuation points shall not exceed the tolerances as stated in tables B.2 and B.3.

Table B.2: Attenuation points close to carrier

Channel separation (kHz)	Tolerances range (kHz)			
	D1	D2	D3	D4
12,5	+1,35	±0,1	-1,35	-5,35
20	+3,1	±0,1	-1,35	-5,35
25	+3,1	±0,1	-1,35	-5,35

Table B.3: Attenuation points distant from the carrier

Channel separation (kHz)	Tolerance range (kHz)			
	D1	D2	D3	D4
12,5	±2,0	±2,0	±2,0	+2,0 -6,0
20	±3,0	±3,0	±3,0	+3,0 -7,0
25	±3,5	±3,5	±3,5	+3,5 -7,5

The minimum attenuation of the filter, outside the 90 dB attenuation points, shall be greater than or equal to 90 dB.

B.1.2 Attenuation indicator

The attenuation indicator shall have a minimum range of 80 dB and a reading accuracy of 1 dB. With a view to future regulations, an attenuation of 90 dB or more is recommended.

B.1.3 RMS value indicator

The instrument shall accurately indicate non-sinusoidal signals in a ratio of up to 10:1 between peak value and rms value.

B.1.4 Oscillator and amplifier

The oscillator and the amplifier shall be designed in such a way that the measurement of the adjacent channel power of a low-noise unmodulated transmitter, whose self-noise has a negligible influence on the measurement result, yields a measured value of ≤ -90 dB for channel separations of 20 kHz and 25 kHz and of ≤ -80 dB for a channel separation of 12,5 kHz, referred to the carrier of the oscillator.

B.2 Spectrum analyser specification

B.2.1 Adjacent and alternate channel power measurement

The characteristics of the spectrum analyser shall meet at least the following requirements:

- the reading accuracy of the frequency marker shall be within ± 100 Hz;
- the accuracy of relative amplitude measurements shall be within $\pm 3,5$ dB.

It shall be possible to adjust the spectrum analyser to allow the separation on its screen of two equal amplitude components with a frequency difference of 200 Hz.

For statistically distributed modulations, the spectrum analyser and the integrating device (when appropriate) needs to allow determination of the power spectral density (energy per time and bandwidth), which has to be integrated over the bandwidth in question. It shall be possible to sum the effective power of all discrete components, the spectral power density and the noise power in the selected bandwidth and to measure this as a ratio relative to the carrier power.

The spectrum analyser should have a dynamic range greater than 90 dB and the average phase noise in the adjacent channels shall be such that measurement of adjacent channel power is not limited by phase noise. In order to confirm this, the selected measurement technique for clause 7.4.2 shall be used to measure the adjacent channel power with a CW signal source with phase noise of less than -120 dBc/Hz in the centre of the adjacent channel. The following performance shall be achieved:

- the maximum adjacent channel power observed with these conditions shall not exceed -70 dBc;

- the maximum alternate channel power measured with these conditions shall not exceed -80 dBc.

NOTE: A resolution bandwidth of 500 Hz may be used for this measurement as an alternative to the usual 100 Hz to reduce measurement time.

B.2.2 Unwanted emissions measurement

The specification shall include the following requirements.

It shall be possible, using a resolution bandwidth of 1 kHz, to measure the amplitude of a signal, or noise at a level 3 dB or more above the noise level of the spectrum analyser, as displayed on the screen, to an accuracy of ± 2 dB in the presence of the wanted signal.

The accuracy of relative amplitude measurements shall be within ± 1 dB.

For statistically distributed modulations, the spectrum analyser and the integrating device (when appropriate) shall allow determination of the real spectral power density (energy per time and bandwidth), which has to be integrated over the bandwidth in question.

B.3 Integrating and power summing device

The integrating and power summing device is connected to the video output of the spectrum analyser, referred to in clause B.2.

It shall be possible to sum the effective power of all discrete components, the spectral power density and the noise power in the selected bandwidth and to measure this as a ratio relative to the carrier power.

Annex C (normative): Relationship between the present document and the essential requirements of Directive 2014/53/EU

The present document has been prepared under the Commission's standardisation request C(2015) 5376 final [i.7] to provide one voluntary means of conforming to the essential requirements of Directive 2014/53/EU on the harmonisation of the laws of the Member States relating to the making available on the market of radio equipment and repealing Directive 1999/5/EC [i.5].

Once the present document is cited in the Official Journal of the European Union under that Directive, compliance with the normative clauses of the present document given in table C.1 confers, within the limits of the scope of the present document, a presumption of conformity with the corresponding essential requirements of that Directive, and associated EFTA regulations.

Table C.1: Relationship between the present document and the essential requirements of Directive 2014/53/EU

Harmonised Standard ETSI EN 300 219				
The following requirements are relevant to the presumption of conformity under the article 3.2 of Directive 2014/53/EU [i.5]				
Requirement			Requirement Conditionality	
No	Description	Reference: Clause No	U/C	Condition
1	Transmitter frequency error	8.1	C	See notes 1 & 6
2	Transmitter carrier power, conducted	8.2	C	See note 1
3	Transmitter effective radiated power, field strength	8.3	C	See notes 1 & 5
4	Transmitter adjacent and alternate channel power	8.4	U	
5	Transmitter spurious emissions	8.5	C	See note 7
6	Transmitter intermodulation attenuation	8.6	C	See note 2
7	Transmitter attack time	8.7	C	See notes 1 & 3
8	Transmitter release time	8.8	C	See notes 1 & 3
9	Transmitter transient frequency behaviour	8.9	C	See notes 1 & 3
10	Receiver maximum useable sensitivity, (responses)	9.2	U	
11	Receiver average useable sensitivity, (responses)	9.3	C	See note 5
12	Receiver co-channel rejection	9.4	C	See note 1
13	Receiver adjacent channel selectivity	9.5	C	See note 1
11	Receiver spurious response rejection	9.6	C	See note 1
12	Receiver inter-modulation response rejection	9.7	C	See note 1
13	Receiver blocking or desensitization	9.8	C	See note 1
14	Receiver spurious radiations	9.9	C	See note 1
15	Receiver desensitivity	10.1	C	See note 4
16	Receiver spurious response rejection (with simultaneous transmission and reception)	10.2	C	See note 4

NOTE 1: Not required if already tested to ETSI EN 300 086 [3].
 NOTE 2: Only applies to fixed base station equipment AND not required if already tested to ETSI EN 300 086 [3].
 NOTE 3: Not required for equipment intended for continuous transmission.
 NOTE 4: Only applies to full duplex equipment AND not required if already tested to ETSI EN 300 086 [3].
 NOTE 5: Only required for equipment without an external antenna connector.
 NOTE 6: Only applies to equipment capable of producing an unmodulated carrier.
 NOTE 7: Not required if performance is evaluated as part of parallel testing to ETSI EN 300 086 [3].

Key to columns:

Requirement:

No A unique identifier for one row of the table which may be used to identify a requirement.

Description A textual reference to the requirement.

Clause Number Identification of clause(s) defining the requirement in the present document unless another document is referenced explicitly.

Requirement Conditionality:

U/C	Indicates whether the requirement shall be unconditionally applicable (U) or is conditional upon the manufacturer's claimed functionality of the equipment (C).
Condition	Explains the conditions when the requirement shall or shall not be applicable for a requirement which is classified "conditional".

Presumption of conformity stays valid only as long as a reference to the present document is maintained in the list published in the Official Journal of the European Union. Users of the present document should consult frequently the latest list published in the Official Journal of the European Union.

Other Union legislation may be applicable to the product(s) falling within the scope of the present document.

History

Document history		
Edition 1	October 1993	Publication as ETSI I-ETS 300 219
Amendment 1	November 1996	Amendment 1 to 1 st Edition of ETSI I-ETS 300 219
V1.2.1/V1.1.1	March 2001	Publication as EN 300 019 part 1 and part 2
V2.1.0	December 2015	EN Approval Procedure AP 20160320: 2015-12-21 to 2016-03-21
V2.1.1	August 2016	Publication